

Fabrication & Installation Guide

Caesarstone Quartz & Caesarstone Mineral™ Surfaces





©Caesarstone Ltd, 2023. All rights reserved. | Manual version August 2023
customer-service@caesarstone.com | mos.caesarstone.com

No parts of this work may be reproduced in any form or by any means - graphic, electronic, or mechanical, including photocopying, recording, taping, or information storage and retrieval systems without written permission from Caesarstone Ltd. This Guide supersedes all previous Guides. Content is subject to change at any time without notice. Please check on the Caesarstone website or with your Caesarstone representative that you are using the latest version. Caesarstone is a registered trademark of Caesarstone Ltd. Products that are referred to in this document may be either trademarks and/or registered trademarks of the respective owners. The publisher and the author make no claim to these trademarks.

Contents

06	1. Introduction
08	2. General Safety
10	3. Slab Information
10	3.1 Slab Data
12	3.2 Slab Stamp
13	3.3 Slab Label
15	4. Handling, Transportation & Storage
15	4.1 Handling
15	4.1.1 Lifting Methods
17	4.2 Transportation
18	4.2.1 Transportation of Fabricated Surfaces
18	4.2.2 Driver Responsibilities
19	4.3 Storage
19	4.3.1 Rack Storage on Angled Posts
21	4.3.2 Storage on A-Frames
22	4.3.3 Dangerous Storage
23	5. Visual Slab Inspection
23	5.1 Inspection Process
25	5.2 Color Matching
26	5.3 Samples vs. Full Slabs
27	6. Tools and Machinery
27	6.1 Required Equipment
27	6.2 Wet Cutting Machinery
27	6.3 Optional Automated Machinery
28	6.4 Required Tools
29	6.5 Installation Accessories
30	6.6 Adhesives

<u>31</u>	7. Pre-Fabrication
<u>31</u>	7.1 Planning
<u>31</u>	7.2 Measuring
<u>32</u>	7.2.1 Measuring by Template
<u>34</u>	7.2.2 Measuring by Dimension
<u>35</u>	7.2.3 Measuring Using Electronics
<u>36</u>	7.3 Slab Optimization
<u>37</u>	7.4 Positioning Joins
<u>39</u>	8. Fabrication
<u>39</u>	8.1 Cutting the Slab
<u>39</u>	8.1.1 Full Body Cutting Considerations
<u>40</u>	8.1.2 Cutting Straight Lines
<u>40</u>	8.1.3 Cutting Curved Lines
<u>41</u>	8.1.4 Cutting Holes
<u>41</u>	8.2 Seams
<u>42</u>	8.3 Cutouts
<u>43</u>	8.3.1 Fabricating Cutouts for Fixtures
<u>44</u>	8.4 Fabricating Edges
<u>44</u>	8.4.1 Single Thickness Edges
<u>45</u>	8.4.2 Laminated Edges
<u>47</u>	8.4.3 Multilayered Edges
<u>49</u>	8.4.4 Miter Edges
<u>51</u>	8.5 Polishing Edges
<u>53</u>	8.5.1 Polished Finishes
<u>54</u>	8.5.2 Concrete, Honed/Matt and Natural Finishes
<u>55</u>	8.5.3 Rough Concrete Finishes
<u>56</u>	8.6 Support Strips

<u>57</u>	9. Installation
<u>57</u>	9.1 Preparing the Base Units/Cabinets
<u>59</u>	9.2 Countertops
<u>59</u>	9.2.1 Preparation for Installation
<u>59</u>	9.2.2 Seaming
<u>61</u>	9.2.3 Sealing Between the Surface and the Wall
<u>61</u>	9.2.4 Attaching Caesarstone Surfaces to Cabinets
<u>62</u>	9.3 Sinks
<u>62</u>	9.4 Cooktops/Hobs
<u>63</u>	9.5 Utility Rooms
<u>64</u>	9.6 Accessories
<u>64</u>	9.6.1 Attaching Accessories Mechanically
<u>65</u>	9.6.2 Attaching Accessories with Adhesive
<u>65</u>	9.7 Overhangs
<u>67</u>	9.8 Tabletops
<u>67</u>	9.9 Finishing Touches
<u>68</u>	10. Care & Maintenance
<u>69</u>	10.1 Stain Removal for Fabricators
<u>75</u>	11. Environment, Standards & Certificates
<u>78</u>	12. Disclaimer

1. Introduction



Caesarstone® quartz and Caesarstone Mineral™ surfaces are ideal for a wide range of interior commercial and residential applications, including: kitchen countertops, bathrooms, bartops, vanities, reception counters and furniture.

Caesarstone quartz and Caesarstone Mineral™ surfaces are not suitable for exterior use, or in any areas that are exposed to UV radiation or excessive heat.

Caesarstone surfaces are manufactured in a vast range of colors, divided into several series with unique properties.

Caesarstone quartz and Caesarstone Mineral™ surfaces are manufactured from raw materials (such as quartz and feldspar) and high-quality polymer resins and pigments that are compacted under intense vibration, vacuum and pressure into dense, non-porous slabs. The slabs are then post cured, gauged to various thicknesses and polished.





2. General Safety

Caesarstone® has always been at the forefront of creating a safe work environment. We require our distributors, fabricators and installers to follow the same level of commitment regarding safety and to comply with local occupational, safety and health regulations.

Fabrication of Caesarstone surfaces generates respirable dust that is dangerous to your health. For more information about this danger and means of protection that you should implement please see the *Caesarstone Good Practice Guide - Steps to Avoid Health Hazards Related to Crystalline Silica Dust* at: mos.caesarstone.com.

I HOUSEKEEPING

Maintain a clean and tidy work area. Ensure housekeeping is regularly monitored to prevent hazards arising from an untidy work environment.

I KEEP WELL VENTILATED

Keep working areas well ventilated and well lit.

I AUTHORIZED PERSONNEL ONLY

Restrict the work area to authorized workers and personnel only.

I PROPER FOOTING

Do not overreach. Keep proper footing and balance at all times.

I FIRST-AID KIT

Maintain a fully equipped first-aid kit appropriate for the tasks being carried out on site at all times.

I READ INSTRUCTIONS

Read the instruction manuals pertaining to the tools used. Learn the tools' application, maintenance, limitations and potential hazards.

I USE APPROPRIATE TOOLS

Use the appropriate tools and attachments per manufacturer's recommendations. Do not use tools or attachments for functions or at speeds for which they were not designed. Do not use improvised tools.

I MAINTAIN TOOLS

All tools must be kept in good working order and tested or serviced per the manufacturer's recommendations.

Wear the following protective apparel when fabricating Caesarstone surfaces:

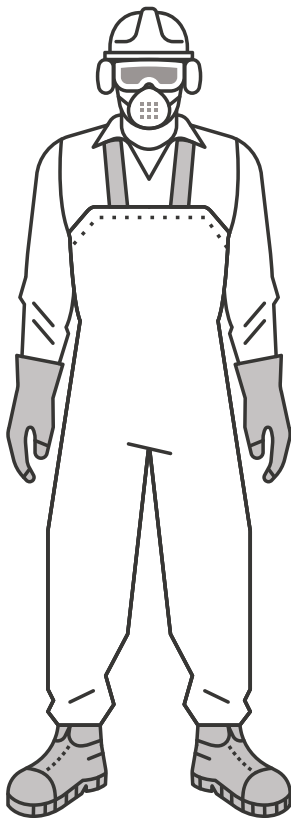

HELMET & HAIR COVERING

Use hair covering to contain long hair and a safety helmet during handling and transporting.



SAFETY GOGGLES

Safety glasses or other approved eye protection.



HEARING PROTECTION

Appropriate hearing protection when working in noisy areas.



GLOVES

Gloves for protection against chemicals or rough material.



RESPIRATORY PROTECTIVE EQUIPMENT (RPE)

A disposable dust mask with P3/N95 filter, a fit-tested half face respirator with P3/N95 filters or higher, or a Powered Air Purifying Respirator (PAPR). The RPE must be suitable for the working conditions and compliant with all relevant standards and regulations. Workers with facial hair should wear PAPR.



SAFETY SHOES

Nonslip, steel-capped safety shoes. In wet areas, steel-capped rubber boots in addition to the above.

GFCI

All electrical tools must be equipped with a Ground Fault Circuit Interrupter (GFCI) or Residual Current Devices (RCDs). Three-prong plugs must be plugged into three-hole electrical sockets. If an adapter is used to accommodate a two-prong socket, the adapter plug must be attached to a known ground. Never remove the third prong.

OPERATE TOOLS SAFELY

Use clamps or a vise to secure work when necessary, freeing both hands to safely operate tools. Ensure that all portable and fixed tooling has appropriately fixed guarding.

REMOVE KEYS

Always remove keys and wrenches. Check that keys and adjusting wrenches are removed before switching on the tool.

DO NOT WEAR JEWELRY

Do not wear neckties, rings, bracelets or other jewelry that may get caught in moving parts.

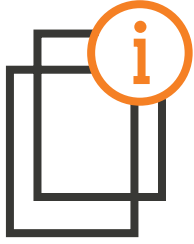

3. Slab Information

3.1 Slab Data

Slab data provided here are nominal only, for storage and transportation purposes. Actual usable slab surface is slightly less per side due to the beveled perimeter.

DIMENSIONS

STANDARD SLAB

Length	3050 mm (120") +/- 10 mm		
Width	1440 mm (56 ¹ / ₂ ") +/- 5 mm		
Thickness	13 mm +/- 1 mm	20 mm +/- 1 mm	30 mm +/- 1 mm

JUMBO SLAB

Length	3340 mm (131 ¹ / ₂ ") +/- 10 mm	
Width	1640 mm (64 ¹ / ₂ ") +/- 5 mm	
Thickness	20 mm +/- 1 mm	30 mm +/- 1 mm



13 mm slabs are available in selected colors.

Note: Imperial measurements in this manual are approximate only.



WEIGHT

STANDARD SLAB WEIGHT	kg	lb
30 mm	290-306 kg	639-675 lb
20 mm	189-210 kg	417-463 lb
13 mm	127-143 kg	280-315 lb

JUMBO SLAB WEIGHT	kg	lb
30 mm	362-382 kg	798-842 lb
20 mm	236-261 kg	520-575 lb

STANDARD & JUMBO WEIGHT	per kg/m ²	per lb/sq ft
30 mm	66-70 kg	13-15 lb
20 mm	43-48 kg	8-10 lb

3.2 Slab Stamp

A stamp appears on the back of the slab with identification information. This information remains on the slab for its lifetime and can be used for identification after installation.

The batch number allows you to track multiple slabs of the same batch. For installations requiring multiple slabs is it important that all slabs come from the same batch.

The slab ID number allows you to identify individual slabs and helps in identifying offcuts that have come from the same slab.

💡 There is no correlation between the batch number and the slab ID.

💡 The inspection date is not the date of manufacture.

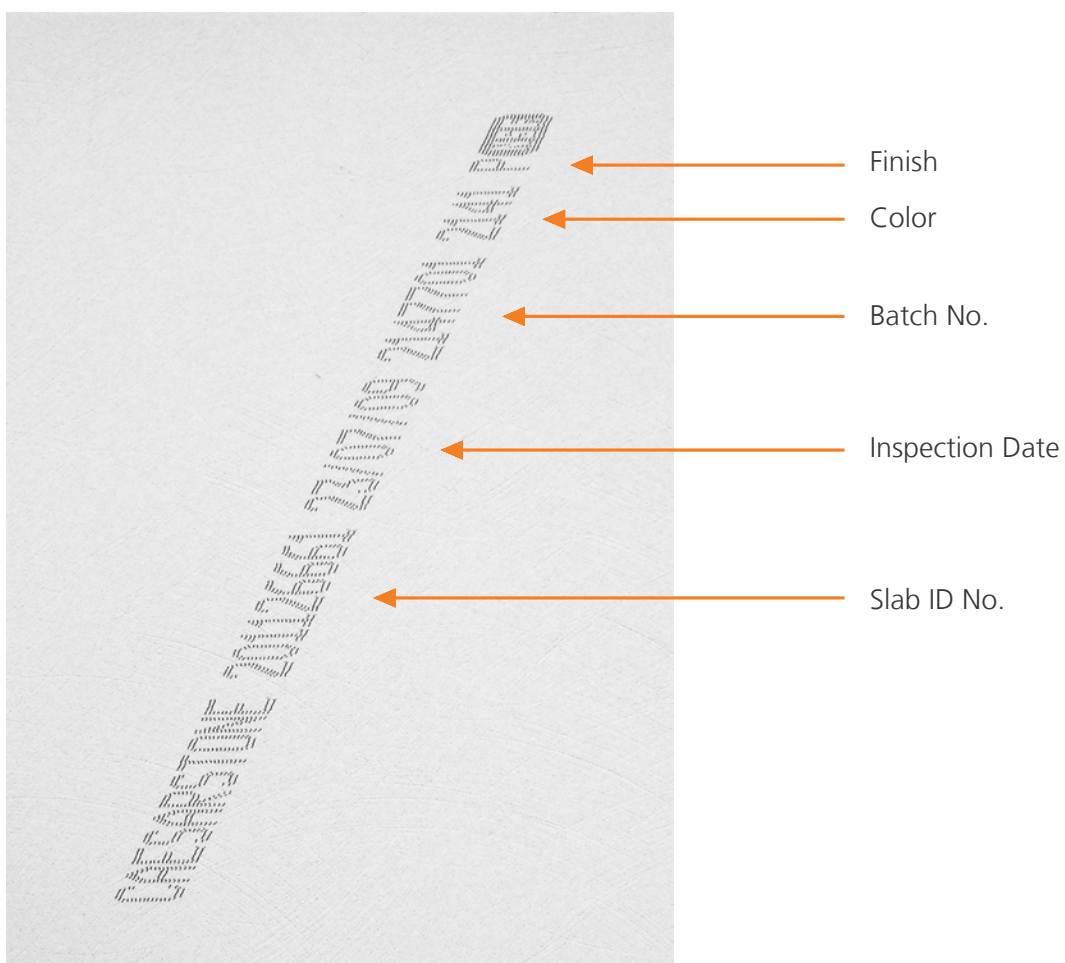

3.3 Slab Label

Every slab manufactured by Caesarstone® undergoes individual inspection and quality control. Below is the key to our slab labels.

CAESARSTONE QUARTZ SURFACES SLAB LABEL



CAESARSTONE MINERAL™ SURFACES SLAB LABEL



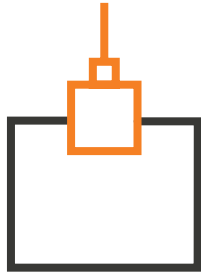

4. Handling, Transportation & Storage

At all stages of handling, transportation and storage, the slabs must be balanced to the center of gravity.

 Adhere to all the relevant safety regulations regarding equipment and personnel.

4.1 Handling

Caesarstone slabs must be loaded, unloaded and transported by means of a forklift, bridge crane or other suitable lifting device.

ENGINEER'S APPROVAL

An engineer who specializes in lifting and handling must approve that all the lifting tools and equipment are in good working order, and that they are suitable for the purpose and the weight of the load.

ARRANGING SLABS

When more than one slab is lifted in one load, the slabs must be back-to-back with no gaps.

PREFERRED ACCESSORIES

The preferred accessories for attaching the slabs to the lifting device are clamps or straps.

4.1.1 Lifting Methods

Take the precautions below when lifting:

- When lifting slabs by scissor lifter or clamp lifter, start lifting the slabs slowly and check that they are firmly secured before transporting them.
- Do not modify the clamps or other lifting mechanisms.
- Do not exceed the load lifting capacity of the lifting equipment.

When lifting or transporting slabs, use the correct lifting equipment certified with safe work load limits. Lift slabs by one of the methods below:

LIFTING STRAPS

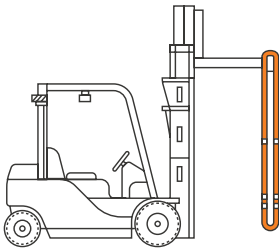

SCISSOR LIFTER

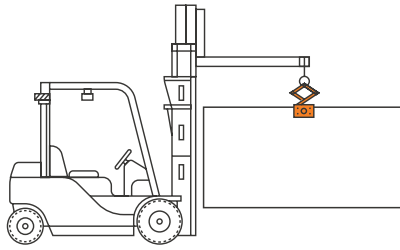

CLAMP LIFTER

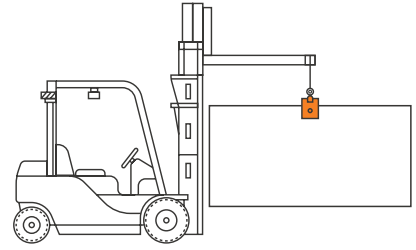

VACUUM LIFTER

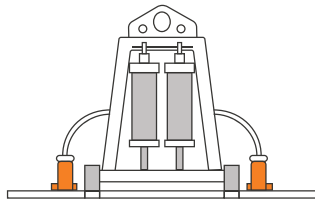

CRANE & SPREADER BEAM

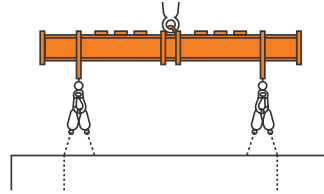

CORRECT USE OF CLAMPS

- Ensure that the slabs are correctly placed into the clamps as shown in this diagram. Failure to do so can result in the slabs falling out or damaging the lifter.
- Some clamps can lift multiple slabs at once, depending on the size of the clamp.
- Do not lift multiple slabs if they are not the same height.

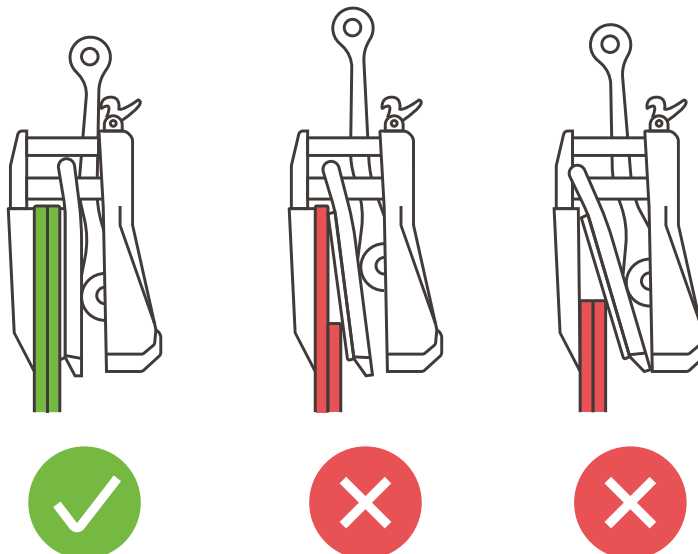

4.2 Transportation

Caesarstone slabs can weigh in excess of 200 kg (440 lb) per slab. All vehicles transporting Caesarstone slabs must be appropriately designed to withstand the weight and safely transport the load. See the diagrams below.

- Securely attach an appropriate, approved frame with no visible defects to the truck for loading Caesarstone slabs, e.g., an A-frame.
- Ensure that the A-frames are appropriately secured to the vehicle and the slabs are appropriately secured to the A-frame so that they cannot move during transportation.
- Load the slabs evenly on both sides of the frame, face-to-face and back-to-back with no gaps.
- Use proper load-rated straps or ratchet tie-downs to secure the load. These should be discarded at the first signs of wear.

 Do not use rope to secure a load; it deteriorates very quickly and has a greater element of elasticity, which reduces its effectiveness.

- Protect the straps from abrasion and damage from the slabs by placing protective strips between the straps and the edges of the slabs.
- The load should be carried completely within the tray of the vehicle so that if a slab breaks, part of it does not fall onto the road and endanger road users.

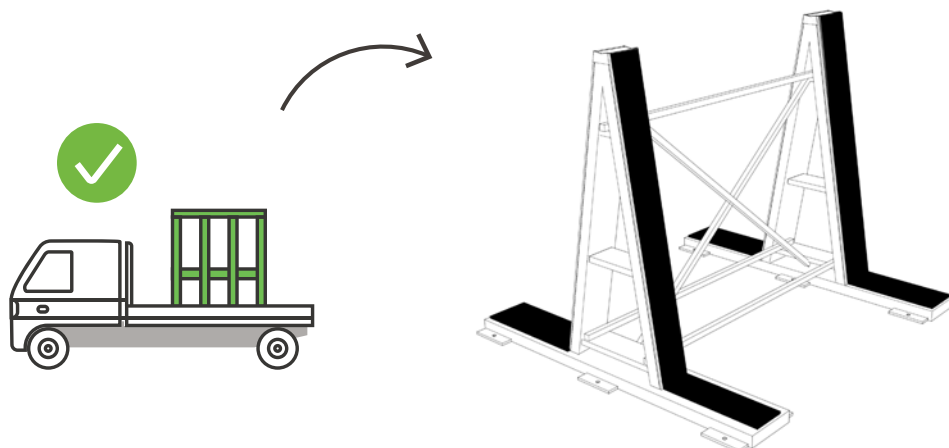
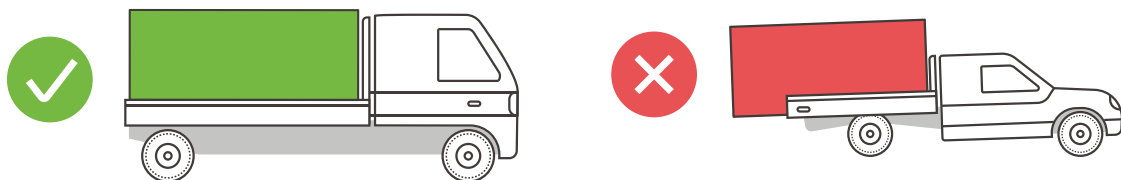

4.2.1 Transportation of Fabricated Surfaces

Correct racking is essential for transporting fabricated pieces to the site in good condition. Please note the specific instructions below in addition to the general instructions.

■ PROTECTIVE LAYER

Ensure that there is a protective layer between the rack and the fabricated pieces to prevent scratching or other surface damage during transit.

■ ARRANGING THE FABRICATED PIECES ON THE RACK

Arrange the fabricated pieces on the rack face-to-face and back-to-back with no gaps. Each piece must be fully supported by the adjacent piece. Place pieces with cutouts in the center of the stack for protection by solid pieces. A protective layer may be placed between cut pieces of different sizes to prevent abrasion lines.

■ SECURE THE SLABS

Safely secure the slabs using the appropriate load-rated securing devices.



4.2.2 Driver Responsibilities

Drivers must stay with their vehicles. Drivers must ensure that:

- the vehicle is in good order and condition
- the load is within the legal carrying capacity of the vehicle, including if it is partially loaded before loading the Caesarstone slabs
- the correct slabs are loaded
- the load is fully supported and safely secured to the vehicle prior to leaving the premises

4.3 Storage

4.3.1 Rack Storage on Angled Posts

The diagrams below show the recommended storage method for Caesarstone slabs.

Caesarstone slabs are heavy and can cause serious injury or death if not safely and securely stored. All slabs must be secured against falling when being stored and transported.

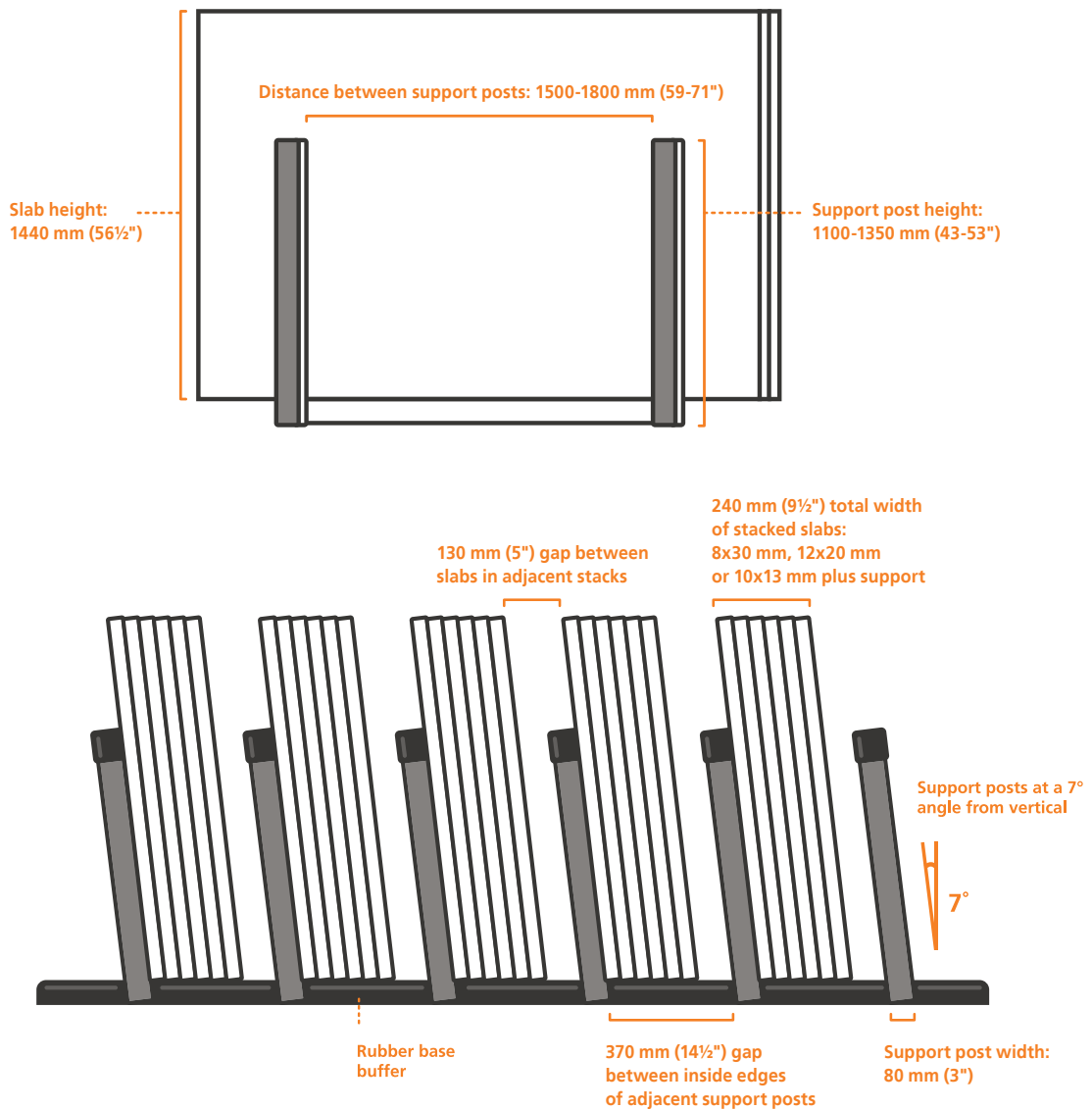

| SUPPORT POSTS

Support the slabs with a minimum of two support posts spaced 1500-1800 mm (59-71") apart, with the slab positioned centrally in relation to the posts. The slab must be in full contact with the whole height of the support posts.

| MAX SLABS IN A STACK

The maximum number of slabs permitted in a stack is as follows:

- 8 x 30 mm
- 12 x 20 mm
- 10 x 13 mm

| 13 MM SLAB ARRANGEMENT

For 13 mm slabs, add two slabs between the stack and the support posts for support; and two slabs on the outer side of the stack for protection. Use 2 x 30 mm, or 1 x 30 mm and 1 x 20 mm slabs, preferably in colors with large granules as they are less flexible.

| STORE UNDER COVER

Caesarstone recommends storing slabs under cover at all times.

| ADDITIONAL SUPPORT IN HIGH TEMPERATURES

If Caesarstone slabs are stored in areas exposed to sunlight or high temperatures it is recommended to provide additional support to prevent warping. This can be achieved by building a third post on the stand, or placing a 30 mm thickness slab against the posts.

| DO NOT EXPOSE THE POLISHED SURFACE

Store the outer slabs in each rack with their backs facing outwards, so that the polished surface is not exposed.

| EASY IDENTIFICATION

Store slabs face-to-face and back-to-back with no gaps, in a manner that allows for easy identification of color and batch numbers.

| CUT SLABS

Do not store cut slabs between full slabs.

| RUBBER BUFFERS

Caesarstone recommends placing rubber buffers on the base of the stand to prevent the slabs chipping.

4.3.2 Storage on A-Frames

Slabs may be safely contained between the uprights of A-frames. This arrangement, although not ideal, is safer than open-ended A-frames. It should be used only as a temporary storage measure.

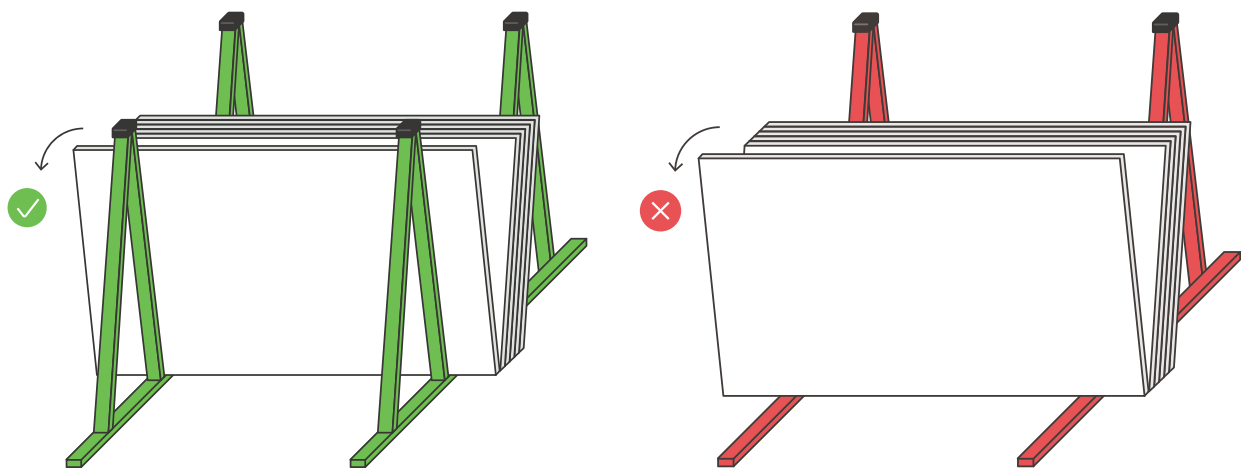

⚠ Do not store slabs on the open ends of A-frames as there is a danger of the slabs falling if tilted too far.

⚠ Do not stand between the slabs; always control the slabs from the outside.

The angle of the frames allows an operator to pry the slabs apart to insert a lifting clamp. However, if pulled too far the slabs will reach a point of no return and can no longer be controlled by the operator.

The 20 mm slabs weigh up to 210 kg (463 lb) and 30 mm slabs weigh up to 306 kg (675 lb). Once these start to tip over it is unlikely that the operator will be able to stop them, which could lead to him being crushed.

4.3.3 Dangerous Storage

This picture shows a dangerous working environment. There are numerous safety issues that could lead to serious injury, such as: no outer support post; uneven ground; no rubber base buffer. In addition, several issues here may damage the slabs: cut pieces placed against or between whole slabs may scratch the slabs; the polished surface exposed to sunlight may fade; unsecured slabs may fall and break; incomplete support may cause warping.



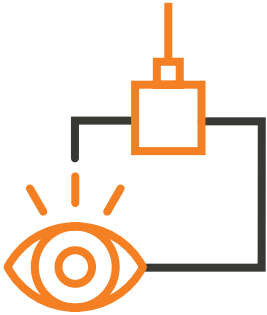

5. Visual Slab Inspection

5.1 Inspection Process

It is **essential** to perform a visual inspection for imperfections on the front and back of all slabs, including the perimeter, before cutting.

■ REMOVE PLASTIC COATING

Caesarstone covers all slabs with a protective plastic coating. **Remove the coating for the visual inspection.**

■ INSPECT WITH LIGHT

Ensure that you are able to inspect the slab under appropriate lighting, either natural or artificial.

■ CHECK FROM VARIOUS ANGLES

Check the surface of the slab from various angles including eye level to pick up any issues that are not apparent when viewing the slab top down.



I FABRICATOR RESPONSIBILITY

Fabricators should perform the visual inspection checks below to determine if any of the listed imperfections exist and if the slab is fit for purpose based on the job layout. If the fabricator deems a slab is not suitable for use based on any of the listed imperfections, he/she should contact Caesarstone immediately. Only slabs that have not been cut or modified in any way will be considered for replacement. Caesarstone reserves the right to make the final determination.

Perform the following visual inspection checks for imperfections:

- Cracks, pits, voids
- Inconsistent gloss levels
- Polishing marks
- Thickness tolerance ± 1 mm
- Warping: up to 3 mm length and 2 mm width when slab horizontal and fully supported

💡 Check length warp using a full-length straight edge with the slab in a horizontal position.

Caesarstone quartz and Caesarstone Mineral™ surfaces are manufactured from natural materials. Variations such as irregular spots, color inconsistency or pattern irregularity within a slab are therefore inherent to the manufacturing process and considered naturally occurring characteristics of the material.



5.2 Color Matching

Caesarstone slabs contain natural raw materials. This may result in slight color and aggregate variations between slabs and production cycles.

I BATCH NUMBER

- Each production cycle carries different batch numbers.
- The batch number appears on the label affixed to all slabs.
- The batch number is also stamped on the back of the slab.

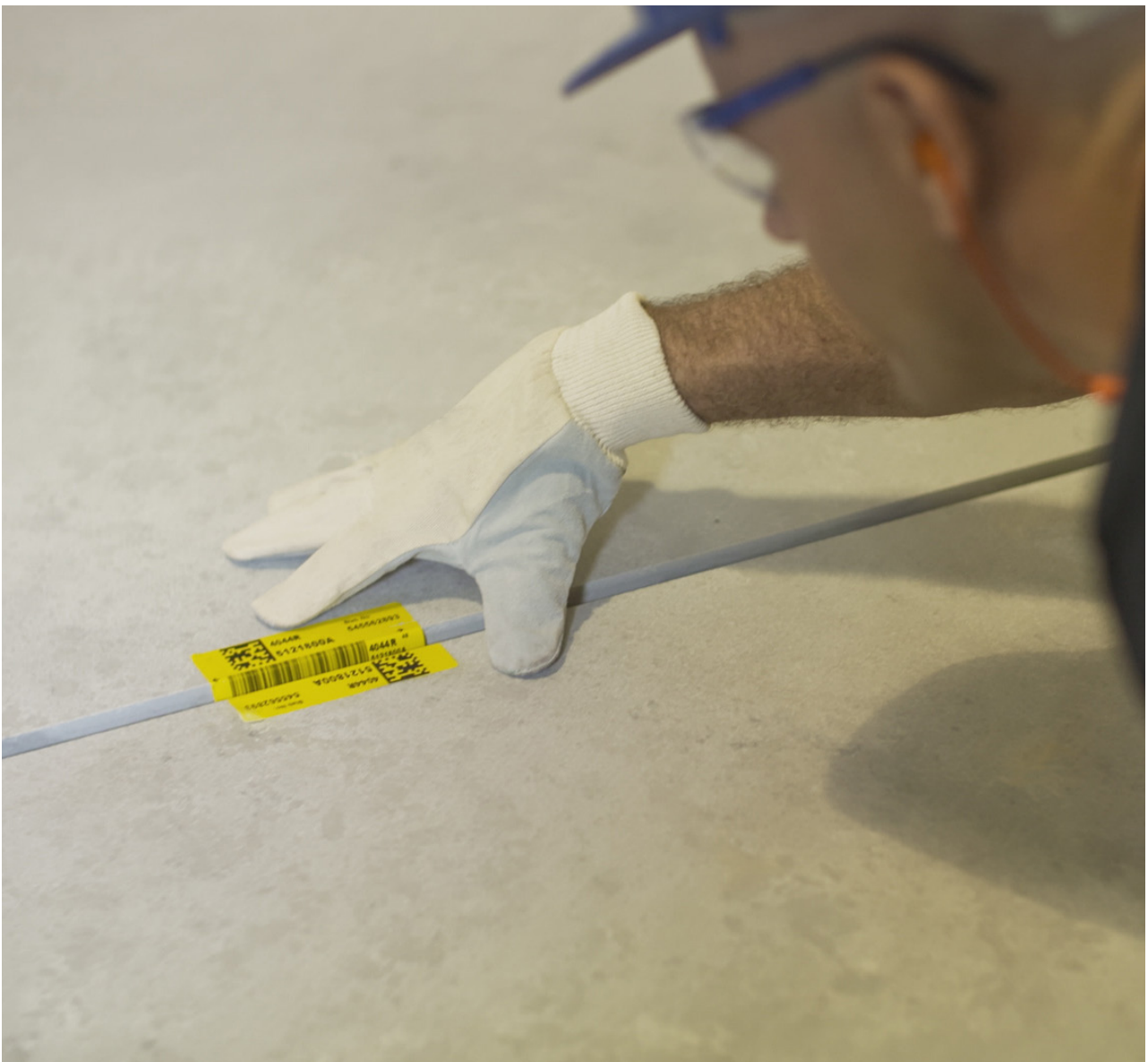

Use slabs from the same batch for each job. This should ensure a color match. However, always perform a visual color match before cutting to confirm consistency in shading.

5.3 Samples vs. Full Slabs

While a sample is good to give an idea of the look and feel of the slab, it is not a complete indicator of the overall effect of the full size slab.

CONFIRM WITH CLIENT

We always recommend that customers view the full slab image, or the actual slab if available, prior to fabrication to ensure that it meets their expectations and to ensure that there are no issues at the time of installation. Our website visualizer enables customers to view full slabs.





6. Tools and Machinery



6.1 Required Equipment

- General ventilation system
- Local exhaust ventilation
- Water recycling system
- Forklift or other lifting device
- Fabrication workbenches in various sizes
- Stone carts/dollies
- Storage racks or A-frame

6.2 Wet Cutting Machinery

One of the below is required for cutting slabs:

- Combined waterjet and diamond blade saw (CNC)
- Waterjet (CNC)
- Automated bridge saw (CNC)

6.3 Optional Automated Machinery

- Edge profiling machine
- Slab polishing machine

6.4 Required Tools

- Heavy duty electric/pneumatic angle grinder for cutting or grinding (variable speed preferred)
- Light electric/pneumatic angle grinder for polishing (variable speed preferred)
- Pneumatic polisher
- Diamond cutting disks in various sizes
- Diamond contour blades
- Diamond core bits in various diameters
- Diamond grinding wheel
- Shaped grinding wheel
- Wet edge profiling machine (edge router)
- Electric hand drill (variable speed preferred)
- Carbide-tipped drill bits
- Polishing drums for polishing inside corners
- Sets of diamond and sanding polishing pads
- Diamond polishing brushes (see section 8.5.3)
- Clamps in various sizes
- Grinding stone
- Pneumatic seam setter

 Consult your local distributor to select the correct diamond tools for cutting Caesarstone slabs.



6.5 Installation Accessories

- Dust collection installation tools
- Vacuum cleaner with (HEPA) filter for dust collection tools
- Seaming clamps
- Pigments (for tinting seam adhesive)
- Cleaning materials
- Spatula and scraper
- Quartz granules (for repairs; contact your Caesarstone representative)



6.6 Adhesives

- To join two pieces of Caesarstone surfaces, use polyester resin adhesive or epoxy-modified acrylic. Suitable Tenax®, Impa®, Akemi® and Integra® adhesives matching Caesarstone's color range are available.* Color-matched adhesive charts can be found on mos.caesarstone.com.

 Please note that these adhesive product recommendations do not apply to the Caesarstone Outdoor product. Please see the *Caesarstone Outdoor Technical Guide* for more information.

- The color-matched adhesive may still require the shade to be adjusted, as there may be minor variations between different batches of Caesarstone slabs.
- Adding transparent adhesive to the color-matched adhesive may improve its properties.
- The color of the adhesive used must match the color of the surface in order to achieve a minimally visible seam. If a pre-colored matching adhesive is not available, mix color paste pigments with the adhesive to achieve a match.
- When mixing the adhesive to color match the surface, take into account that the color may be slightly lighter after drying.
- To join Caesarstone surfaces to a different material, use a flexible adhesive such as 100% silicone or polyurethane-based adhesives suitable for both Caesarstone surfaces and the material to which it is joined.

Note: Before using, please read and follow the adhesive manufacturers' instructions, including regarding safety.



* Tenax®, Impa®, Akemi® and Integra® are trademarks of their respective owners.

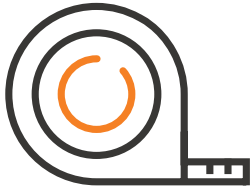

7. Pre-Fabrication

7.1 Planning

■ CHECK THE SUBSTRATE

Check that the substrate (the kitchen cabinet in the case of a kitchen countertop) is in its correct and final location, level and ready for the surface to be installed.

■ SIZE, SHAPE AND LOCATION

Plan the size, shape and location of the surface pieces. See section 7.4 for considerations regarding placement of joins.

■ MINIMIZE WASTAGE

Plan the fabrication of rectangular pieces as far as possible in order to minimize wastage of the slab.

■ ALLOW FOR REMOVAL OF PERIMETER

Take into account that a minimal amount of the outer perimeter of the slab will be removed in order to straighten the edges.

7.2 Measuring

■ MEASURING METHODS

The three most common methods of measuring are: by template; by dimension; and by electronic devices as described in sections 7.2.1, 7.2.2 and 7.2.3.



7.2.1 Measuring by Template

- Mark on the cabinets the location of the seams to be fabricated in the surface.
- Construct a solid template or frame template for each piece of the surface as described below.
- Mark on the template the center point of items to be installed in the surface, such as sinks and cooktops/hobs.
- Verify the location and the space available for items to be installed in the surface, taking into account the relation between the items and the surrounding area, e.g., a cooktop/hob centered underneath a vent; a sink centered underneath a window.
- Mark on the template any required information for fabrication, e.g., edges requiring polishing, adjoining edges, etc.
- Take a few control measurements in order to confirm the angles, dimensions and arrangement of the cut pieces later in the workshop.
- Transfer the template measurements to the slab by one of the following methods:
 - Lay the template on the slab and copy it onto the slab.
 - Scan the template in an industrial scanner. The scanner converts the template measurements into shapes and dimensions and sends them to the computer of the cutting machine.

Constructing a Solid Template

Caesarstone recommends constructing solid templates out of polypropylene sheets cut to size, as follows:

- Place the polypropylene sheets on the cabinet.
- Position the edges of the sheet to correspond with the seam lines and the edge of the cabinet or the wall.
- Cut the template to the external shape and dimensions required, including overhangs and space allowed for circumferential gaps.

 It may be necessary to join two or more sheets of polypropylene to create the correct size and shape for each part of the template.

 Caesarstone does not recommend the commonly used method of constructing templates out of cardboard as it is easily damaged and distorted.

Constructing a Frame Template

- Construct a frame template out of any light, stable, rigid material, using plastic strips approximately 70-100 mm (2¾-4") wide and 3-4 mm (⅛") thick.
- Position length strips along the length of the surface piece, including overhangs and space allowed for circumferential gaps. Align the ends of the length strip with the seams marked on the cabinet.
- Glue plastic width strips approximately every 300-400 mm (12-16") across the width of the template with rapid-drying adhesive. Align the two end width strips with the seams marked on the cabinet.

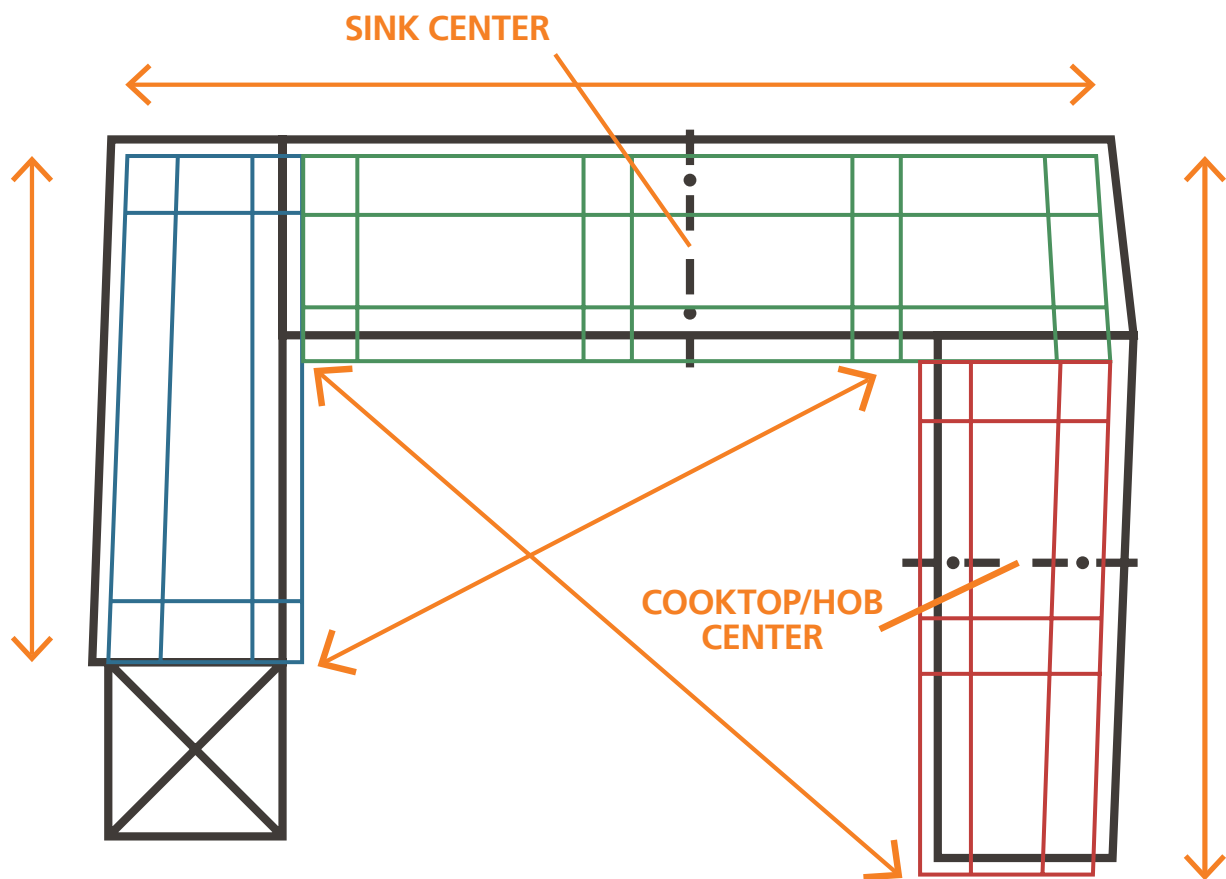

Example of template

7.2.2 Measuring by Dimension

- Create a clear diagram on which to record the measurements, preferably on a computer or professional drawing board with a ruler.
- Use the front line of the installation as the central line of the diagram from which to draw all other measurements. If the front line is not perfectly straight, create a straight line on the cabinet to use as the central line.
- Mark on the diagram the center point of items to be installed in the countertop, such as sinks and cooktops/hobs.
- Check that the sum of the dimensions that make up one side are equal to the length of the whole side.
- Do not assume that corners are exact 90° angles. Measure the sides or use an angle measure. A deviation of 1° in a 90° angle creates a deviation of 52 mm per 3 m (2" per 118")!

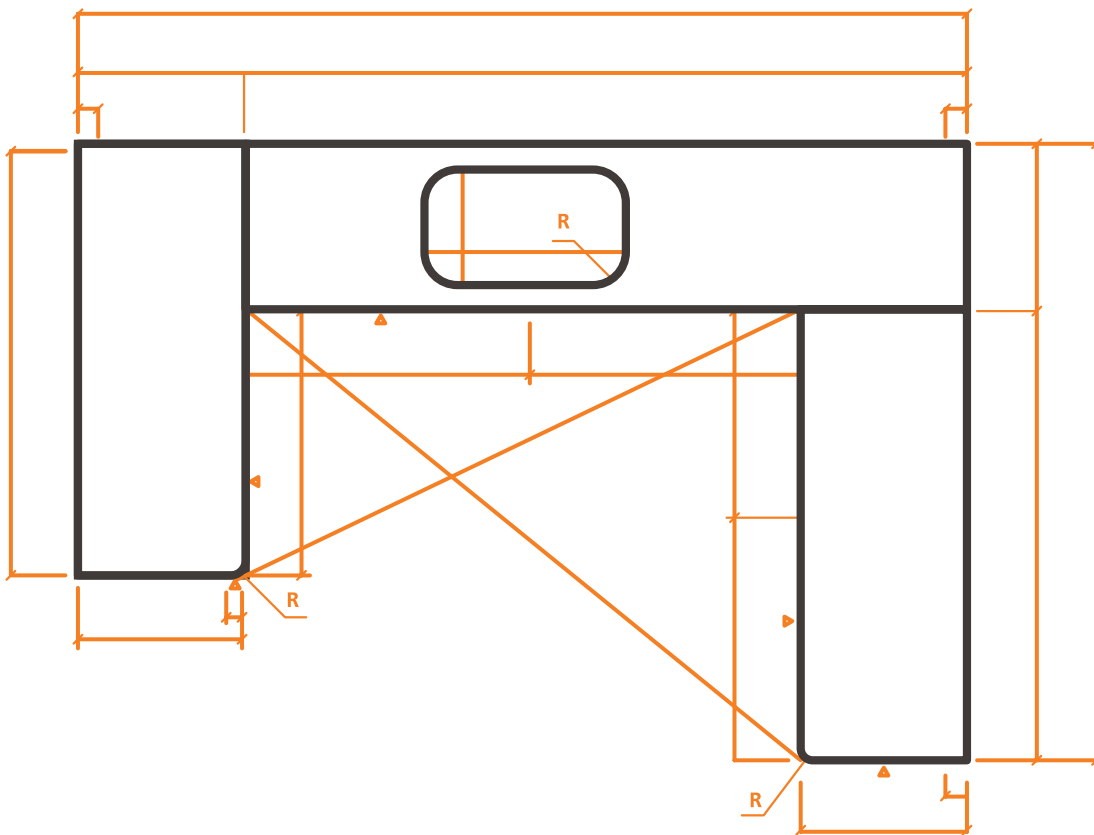

 Measuring can also be performed via laser, which is automatically converted by computer software into a work plan.

7.2.3 Measuring Using Electronics

Advanced electronic measurements that produce a form of CAD file can be made using a variety of technologies including e-templating, Proliner® and LT-2D3D™ Laser Templators.* These have major benefits to fabricators using CAD files for automated equipment like CNCs and Water Jet cutting.

Only those trained on the equipment should use it and care should be taken to check several dimensions manually to ensure the equipment is functioning correctly.

All critical points must be recorded to allow the equipment to create an accurate file and the trained operator must add details such as overhangs, radiuses, sink locations, etc. Finished edges must be indicated and defined.

These units will typically give accuracy to within 2 mm ($1/16$ ") but still require someone with knowledge of installation challenges to be present on site.

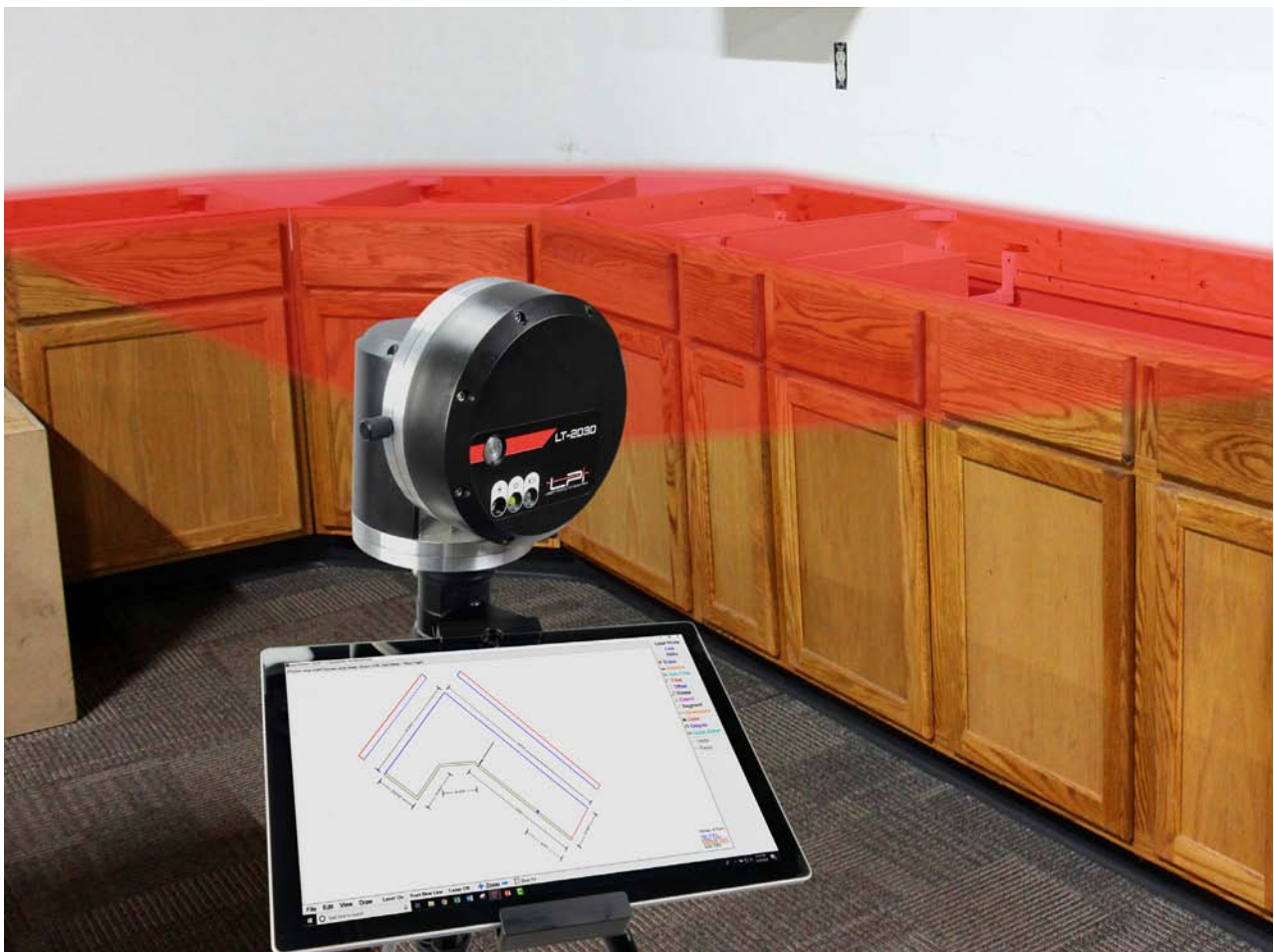

LT-2D3DTM Laser Templator

* Proliner® is a trademark of PRODIM INTERNATIONAL. BV; and LT-2D3DTM is a trademark of Laser Products Industries.

7.3 Slab Optimization

MINIMIZE WASTAGE

Plan the arrangement of the pieces to be cut from the slab to minimize wastage. Take into account that a minimal amount must be cut off the outer perimeter of the slab in order to straighten the edges.

CHECK FLATNESS

Check the flatness of the surface at the locations planned for seams.

VISUAL CONSISTENCY

When cutting slabs, try to keep ends cut from adjoining sections of the same slab butted up together. This will provide the best match for pattern arrangement and color consistency. This is particularly recommended for installations in areas with a high amount of reflected light.

SLAB ORIENTATION CONSISTENCY

When extra-long benchtops are needed, you will need to add an extension piece to the end of the primary slab. We highly recommend that the extension piece be cut from a slab in the same orientation as the primary slab.

It is possible to create 7.2 m (283") of countertop from one slab.



Example of template arrangement before cutting the slab.

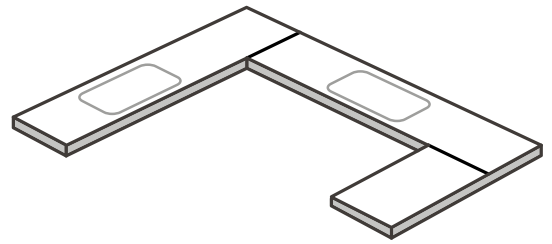

Example of plan of slab pieces

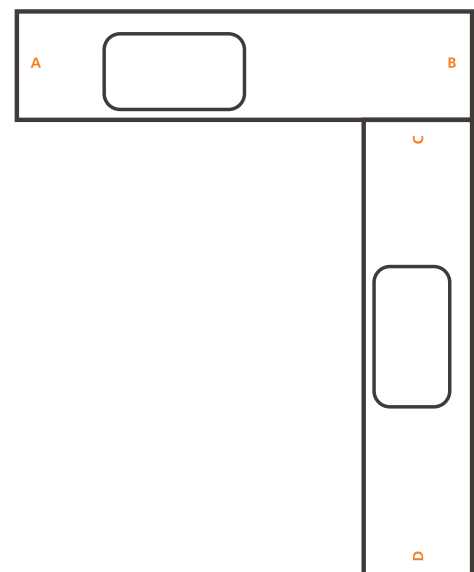
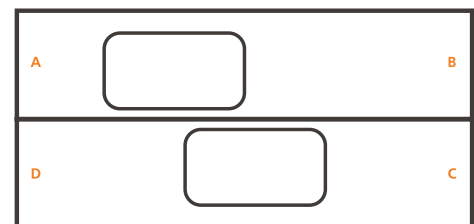

7.4 Positioning Joints

Caesarstone recommends fabricating a straight joint for each change of direction in the countertop (figure 1). Countertops without a joint are more likely to crack during transportation, installation, and post-installation.

For single thickness countertops fabricated without a joint, the inside corner must have a minimum 10 mm (3/8") radius (figure 2). The larger the radius, the stronger the corner. It is not recommended to fabricate a 90° angle on an inside corner (figure 3).

Cracking does not indicate a material fault; it is the result of externally induced, mechanical stress on the countertops. The two most common sources are heat (thermal shock) causing expansion or contraction, or high point loads.

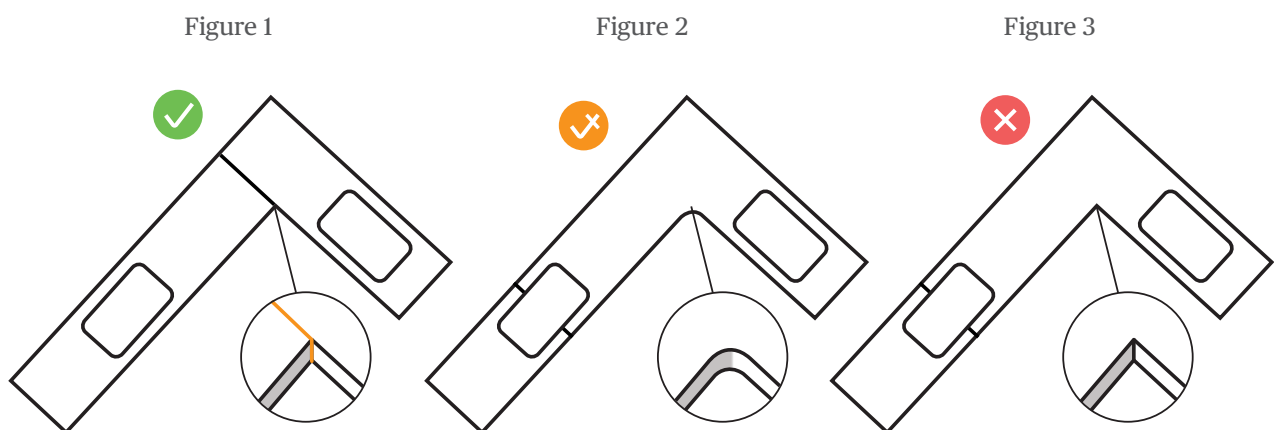

Diagonal Joins

Caesarstone recommends using diagonal joins only when necessary for the continuation of veins or a pattern in the slab; see figure below.

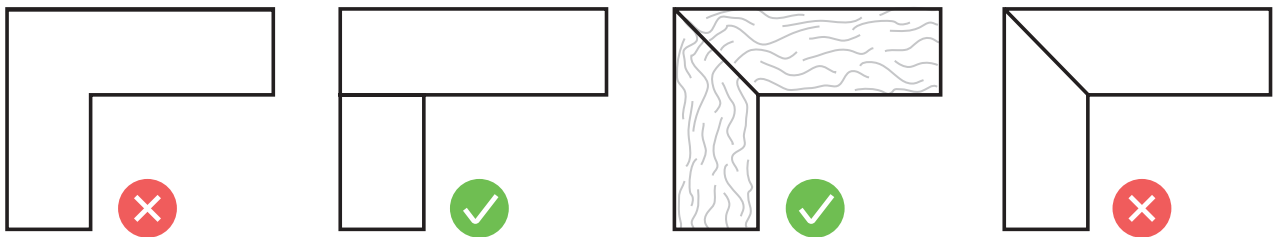



8. Fabrication

8.1 Cutting the Slab

IMPORTANT! Use only water-cooled tools for cutting, drilling and polishing in order to prevent overheating and generating dust. If a Caesarstone slab is dry cut, the generated heat will undermine its physical properties and make it more susceptible to cracking, chipping, discoloration and other damages.

Any issues or failures caused by dry cutting are not covered by the Caesarstone warranty.

I REMOVE SLAB PERIMETER

Before cutting to plan, cut a minimal amount off the outer perimeter of the slab in order to straighten the edges.



Before the slab is cut, check the color match of the pieces to be seamed.



Use a silica stone to keep diamond cutting tools sharp.

8.1.1 Full Body Cutting Considerations

- Caesarstone slabs are full body in that the materials are integral to the body of the slab, rather than limited to a surface layer or printed on the top.
- The veins in Caesarstone slabs are not designed to penetrate the whole depth of the slab. In some cases, they can reach the back of 20 mm slabs but as this is not the case in all slabs, applications cannot be planned assuming this.
- If it is necessary for the design to appear on both sides of the slab, we recommend joining two slabs with the top surfaces facing outwards.

-
- We do not recommend polishing the back of slabs as the factory-polished side can easily be damaged during the process.

8.1.2 Cutting Straight Lines

| AUTOMATED

Machine cut straight lines with a CNC.



Be sure to use the correct diameter diamond disk for the machine and the material.

8.1.3 Cutting Curved Lines

| AUTOMATED

Machine cut curved lines by one of the following methods:

- CNC with water-cooled diamond finger bit
- Water jet cutter

| MANUAL

Cut curved lines manually by one of the following methods:

- Router with water-cooled diamond finger bit
- Grinding wheel with water-cooled concave diamond disk



8.1.4 Cutting Holes

| AUTOMATED

Machine cut holes by one of the following methods:

- Drill with water-cooled diamond core bit
- CNC with water-cooled diamond core bit
- Water jet cutter

| MANUAL

Cut holes manually with a carbide-tipped drill bit (for small holes) or a diamond core bit mounted on a suitable water-cooled angle grinder or manual drill (for larger holes).

8.2 Seams

| BONDING AREA FOR ADHESIVE

Cut an X-shaped pattern approximately 1 mm ($\frac{1}{32}$ ") deep in the edges to be seamed in order to enhance the bonding area for the adhesive.

| SUPPORT STRIPS

Attach wooden support strips to the cabinetry under seams. The center of the seam should rest on the support strip.

| SUPPORT IN AREAS OF HEAT

We suggest the use of a full subdeck for added support in areas of heat.



Do not polish seams on Caesarstone surfaces.



Use of acetone is forbidden on Caesarstone surfaces. Alcohol is recommended for cleaning during installation.

8.3 Cutouts

Cutouts are usually created in countertops for the installation of sinks, cooktops/hobs and other fixtures.

- Fabricate cutouts according to the instructions of the fixture manufacturer.
- Fabricate a minimum radius of 10 mm ($\frac{3}{8}$ ") with a core bit/cup drill for all seen and unseen corners in cutouts; see figure 1. The larger the radius, the stronger the corner.
- In the event that fabricating a 10 mm ($\frac{3}{8}$ ") cutout corner radius would prevent the proper installation of an item that requires a 90° angle corner, drill beyond the corner with a core bit/cup drill; see figure 3.
- Take care not to cut beyond the rounded edge in cutouts as in figures 2 and 4. Damage to the area may lead to the formation of hairline cracks.
- Do not cut square corners or cross cut corners as in figures 5 and 6.
- Do not cut a large radius in sections as in figure 7.

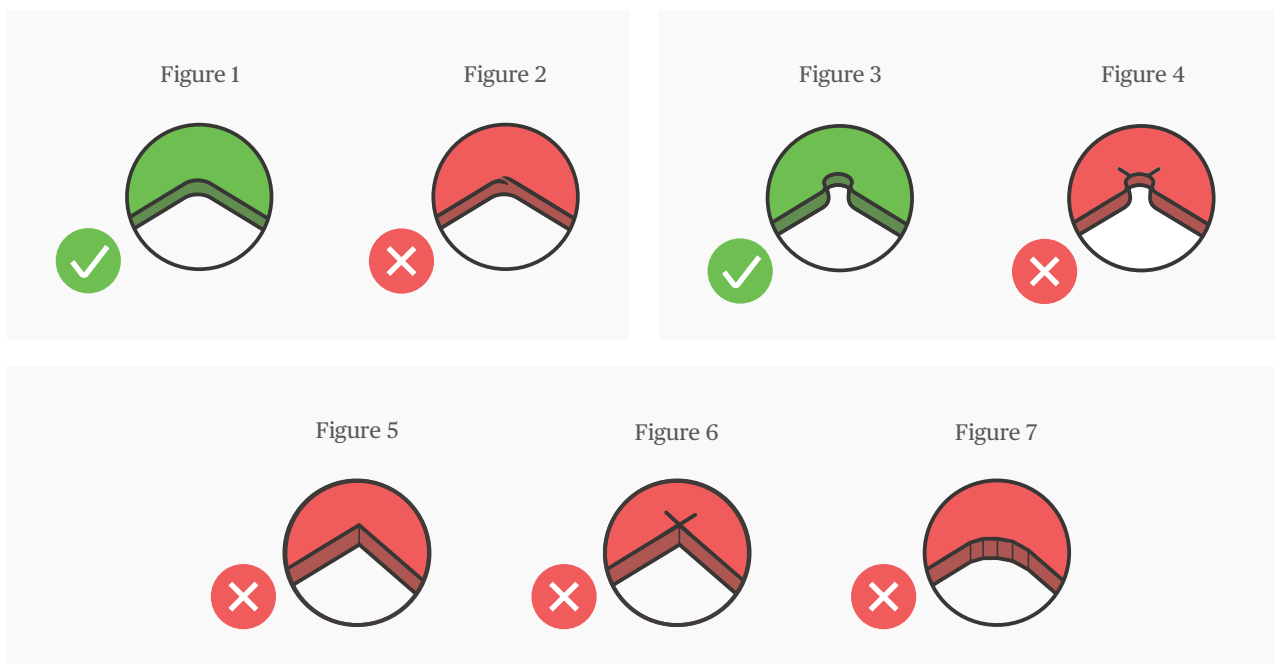

- Do not reduce the thickness of the surface when preparing the cutout.
- The distance between a cutout and an edge or seam must be no less than 50 mm (2"). The greater the distance, the stronger the area.
- If the distance between a cutout and an edge or seam is less than 150 mm (6"), the area must be supported by a support strip of Caesarstone surfaces.

8.3.1 Fabricating Cutouts for Fixtures

It is generally necessary to install fixtures such as sinks and cooktops/hobs in countertops. Below are the main methods of installing fixtures, each of which requires a different type of cutout fabrication.

Ensure that the fixture is fully supported inside the cabinet, e.g., by support rails or legs connected to the cabinet, in addition to being attached to the Caesarstone surface.

OVERMOUNT INSTALLATION

- In overmount installation, the lip of the cooktop/hob or sink extends above the surface and rests on it. Smooth the edge of the cutout and leave it unpolished. Leave a space between the fixture wall and the surface.

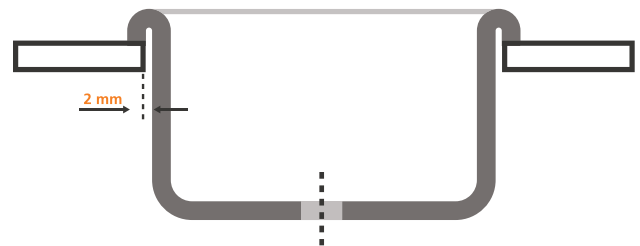

FLUSH-TO-BOWL UNDERMOUNT INSTALLATION

- Some installations require a cutout that is flush to the inside wall of the sink. This typically reduces the exposure of the bonded edges but is difficult to produce exactly to match the sink.



STEPPED BACK TO CURVE OR BEVEL OF BOWL INSTALLATION

- Some installations and most templates provided by sink manufacturers have the finished edge of the counter set back to the edge of the rounded or beveled top of the sink bowl with a minimum amount of flat deck of the sink showing.

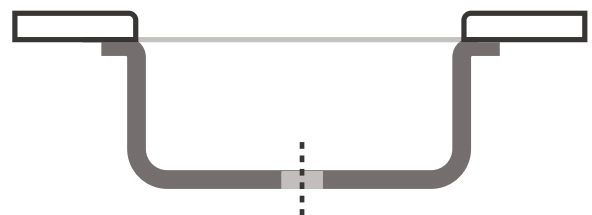

OVERHANG INTO BOWL UNDERMOUNT INSTALLATION

- In undermount installation, the sink is positioned underneath the surface.
- Fabricate the cutout slightly smaller than the sink aperture so that the join between the sink and the surface is not visible. Round or bevel the top and bottom edges of cutout.

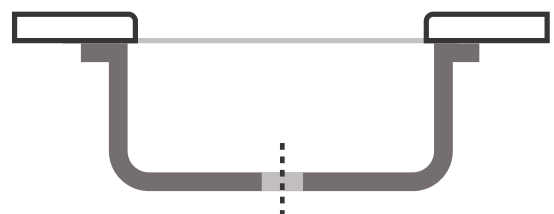

8.4 Fabricating Edges

VISIBLE EDGES

All visible edges must be polished to the same finish as the surface.

TOP OF EDGES

The top of edges must be rounded or beveled. Do not create square edges.

MINIMUM EDGE PROFILE

All edges must have a minimum edge profile of 3 mm ($\frac{1}{8}$ "). The larger the surface area of the edge, the more resistant it is to chipping.

EDGE DETAILS

The most common edge details are radius or 45° bevel; however, there is a very wide range of detail options.

CONFIRM WITH CUSTOMER

Before cutting, visually confirm the edge profile with the customer as edge terminology can vary between different companies and regions.

8.4.1 Single Thickness Edges

Single thickness edges are the original thickness of the slab.

- Single thickness edges are easily and quickly fabricated.
- Most automated edge profiling machinery is designed to create single thickness edges.

Beveled edge 4-6 mm ($\frac{1}{16}$ - $\frac{1}{4}$ ")
recommended

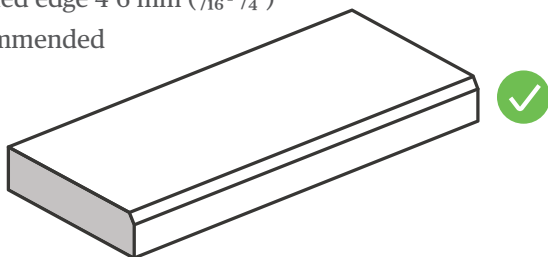

Pencil round 4-6 mm ($\frac{1}{16}$ - $\frac{1}{4}$ ")
recommended

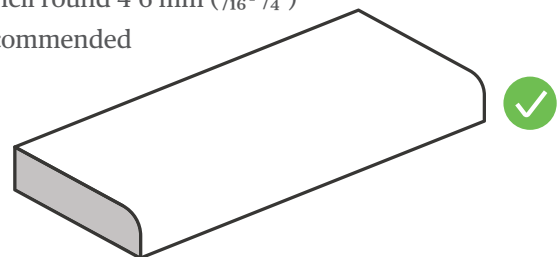

Square edge not recommended as
impact may cause chipping

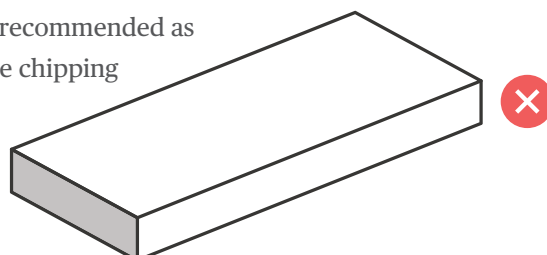

8.4.2 Laminated Edges

Lamination is the process of gluing one or more strips of Caesarstone surfaces along the bottom edge of another piece of Caesarstone surfaces in order to create the illusion of a thicker slab. This process is more complex and time consuming than fabricating single-thickness edges; however, it produces a richer aesthetic effect.

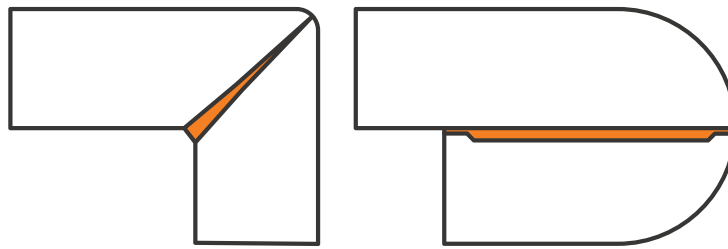

I COLOR MATCH LAMINATION STRIPS

Cut lamination strips from the same slab as the countertop, and wherever possible from the same saw cut to ensure a color match; see below.

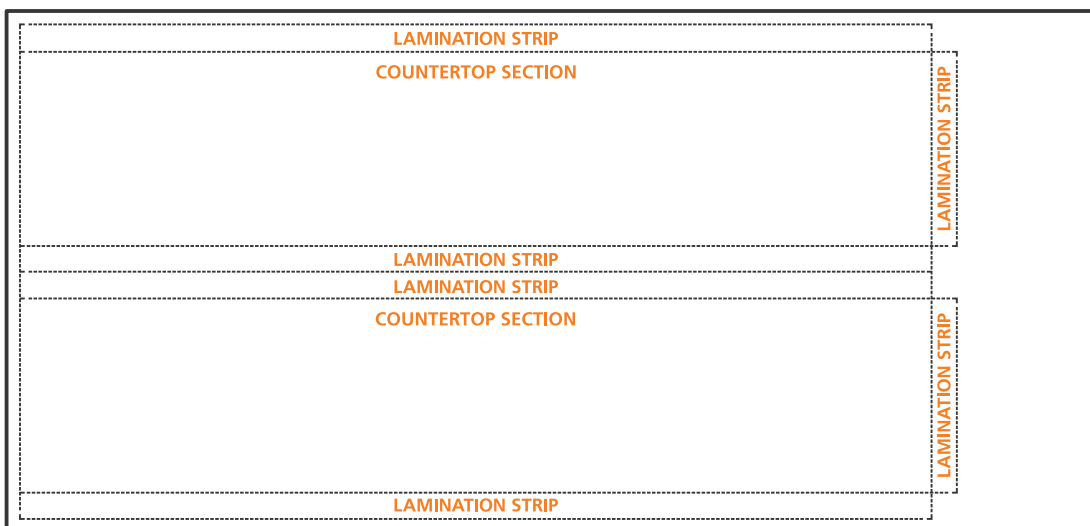

I ALIGN JOINS WITH SEAMS

The lamination strip should be the same length as the piece of surface to which it is attached. Joins in lamination strips will, therefore, be aligned with the surface seams.

I MITER CUT EDGES

The preferred method of laminating edges requiring longer edge skirts is the miter cut; see section 8.4.4.

POSITIONING LAMINATION STRIPS

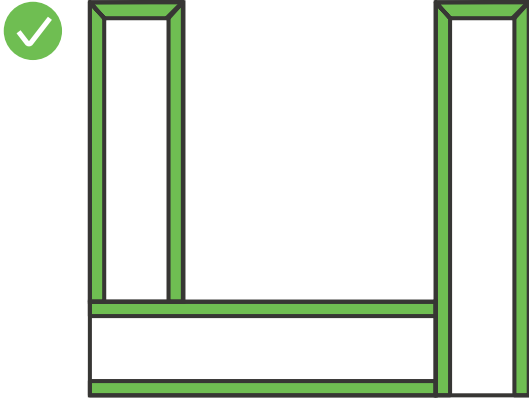

Underside of countertops showing correct positioning of lamination strips

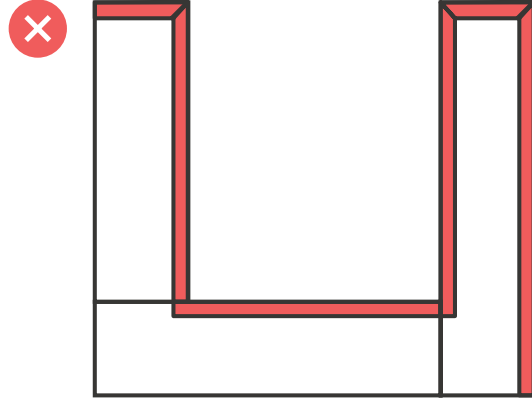

Underside of countertops showing **incorrect** positioning of lamination strips

Underside of island bar showing lamination strips in place plus an exploded view of the lamination pieces. Island bar laminations should follow the full perimeter of the countertops. If you require a full thickness lamination under the overhang use a separate infill piece as shown here.

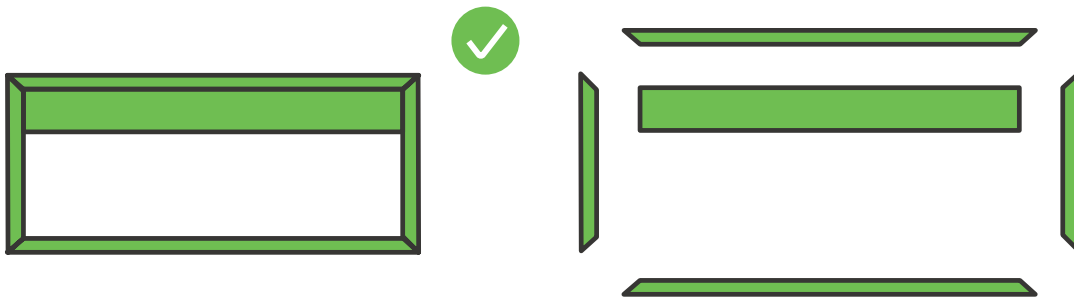

8.4.3 Multilayered Edges

Characteristics of Multilayered Edges

- Multilayered edges are fabricated by adding one or more lamination strips underneath the outer edge of the surface.
- Triple or more edges enable various design options such as using lamination strips of different thicknesses and/or colors, and by recessing one or more of the lamination strips.
- This is the method used for creating the popular double bullnose.

Fabrication of Multilayered Edges

REDUCE

Before gluing the lamination strip to the underside of the surface, reduce the lamination strip from approximately 3 mm ($\frac{1}{8}$ ") behind the edge to ensure flush closure of the visible joint and to leave space for the adhesive.

Leave a few unreduced points on the strip to maintain the full height of the strip when attached to the surface.

CHECK FLUSH JOINT

Place the reduced lamination strip against the underside of the surface to check the closure of the joint. If it is not perfectly flush, smooth the points of contact until the edges are flush.

GLUE

Glue the lamination strip to the surface.

CLAMP

Clamp the strip to the surface at regular intervals, sufficient to achieve a good, even bond between the two surfaces whilst eliminating any visible glue lines.

POLISH

After gluing the lamination strip to the surface, polish the entire visible area of the edge.

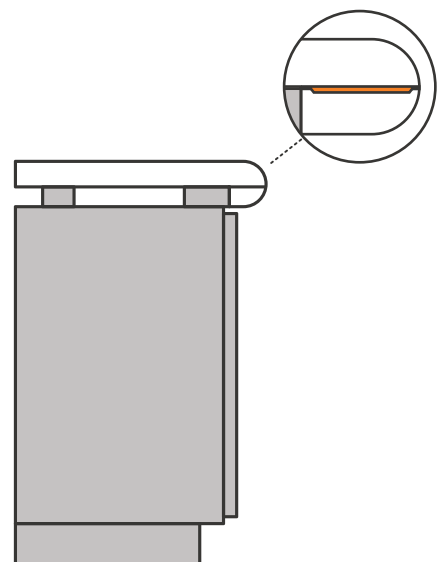



8.4.4 Miter Edges

Characteristics of Miter Edges

- Miter edges allow the fabrication of edges of any height. The height of the edge is independent of the thickness of the slab.
- Miter edges enable the continuation of a pattern around an edge.
- Miter edges can be used to create edge profiles of various depths.
- It is not necessary to polish the vertical part of the miter as the visible area is the polished surface of the slab.

Fabrication of Miter Edges

I CUT STRIP

Cut a strip from the slab. The width of the strip must be the same as the height required for the miter edge.



For miter edges on Caesarstone models with prominent designs, cut the slab at the location planned for the miter join for continuation of the slab pattern.

I STANDARD MITER JOIN

Fabricate miter edges at a 45° angle to ensure maximum strength and enable a final edge angle of 90°. An angle of less than 45° makes the edge prone to chipping. Distribute the adhesive evenly throughout the joint. Polish the miter edge to a radius or bevel profile as required.



A join in the middle of a small radius or bevel makes the edge prone to chipping. It is therefore recommended to create a large radius.

I HIGH-STRENGTH MITER JOIN

For areas subject to greater stress, after cutting the 45° angle, reduce the angle slightly on the back part of the miter with a manual tool to create space for the adhesive. This allows for a stronger joint and flush closure on the visible part of the miter.

DO NOT CREATE ANGLES LESS THAN 45°

These joints produce a thin wedge at the tip of the miter, making it more susceptible to chipping or breaking. Also, the greater the edge radius, the more joint adhesive is visible.

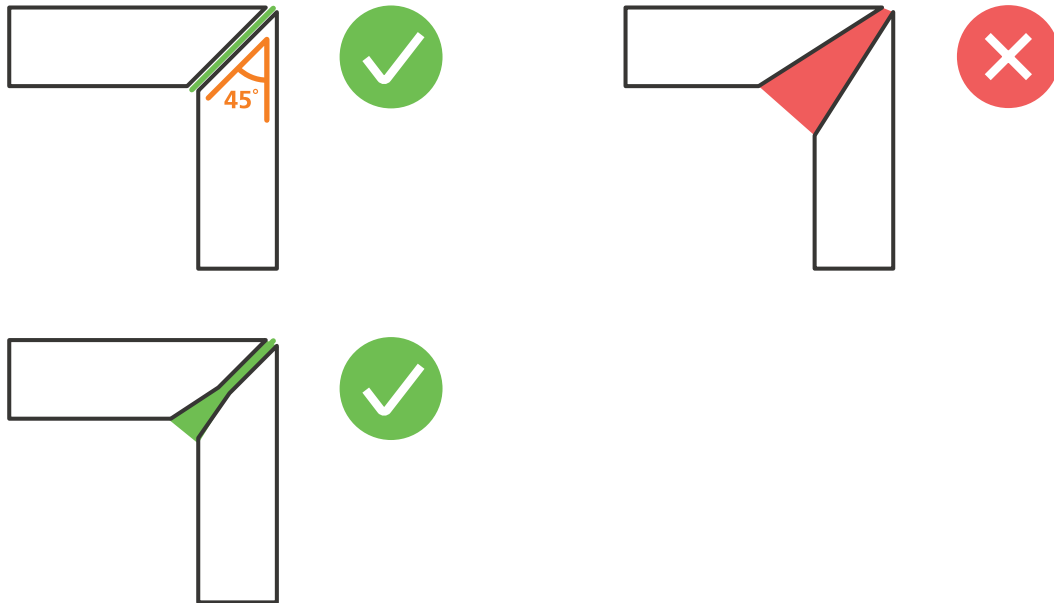

 It is recommended to use a miter clamp in order to create an accurate 90° angle, to tighten the joint and prevent the adhesive showing.

SHADOW LINE

Another alternative is to use a 5 mm x 5 mm shadow line joint. This joint is recommended for waterfall ends that reach the floor. It also allows for more movement in the cabinets over time.

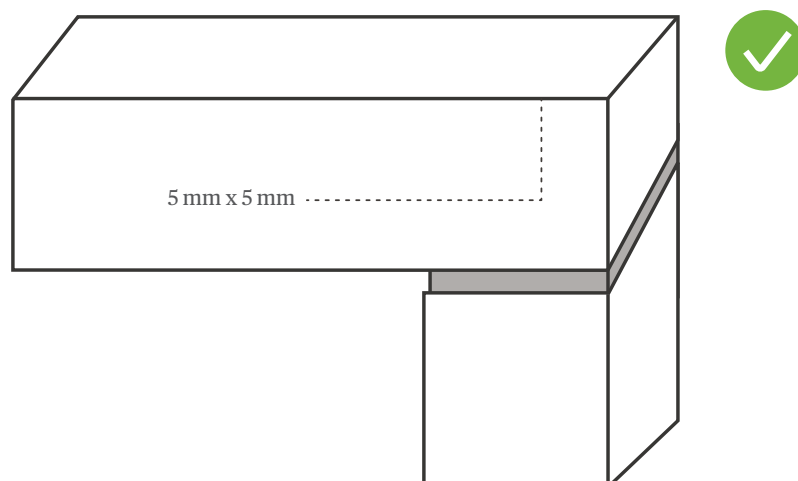

8.5 Polishing Edges

Follow the guidelines below to achieve an edge polish equal to the factory surface polish.

General Guidelines

 Never polish the face of the surface, only the edge!

- Ensure that the area to be polished is clean of debris.
- Use water-cooled tools for polishing; dry polishing may overheat and damage the area.
- Use a polishing bob/drum for polishing rounded or curved inside corners and small cutouts with exposed edges.
- Each stage of polishing should remove the marks of the previous stage. When a uniform finish is achieved, progress to the next stage.
- Do not polish edge profiles in excess of the factory surface polish.

 When a significant amount of material must be removed from the edge, a water-cooled diamond grinding wheel can be used before the coarsest pad.

 It is recommended NOT to use polishing stones for manual polishing.

Methods

Edges may be polished using 4-step wet polishing pads for quartz; or with the traditional polishing method detailed below:

- Use suitable diamond polishing pads with water.
- Perform polishing by progressing through the various grit sizes from coarse (lower number) to fine (higher number).
- Polish edge profiles in a progressive manner according to the tables provided.

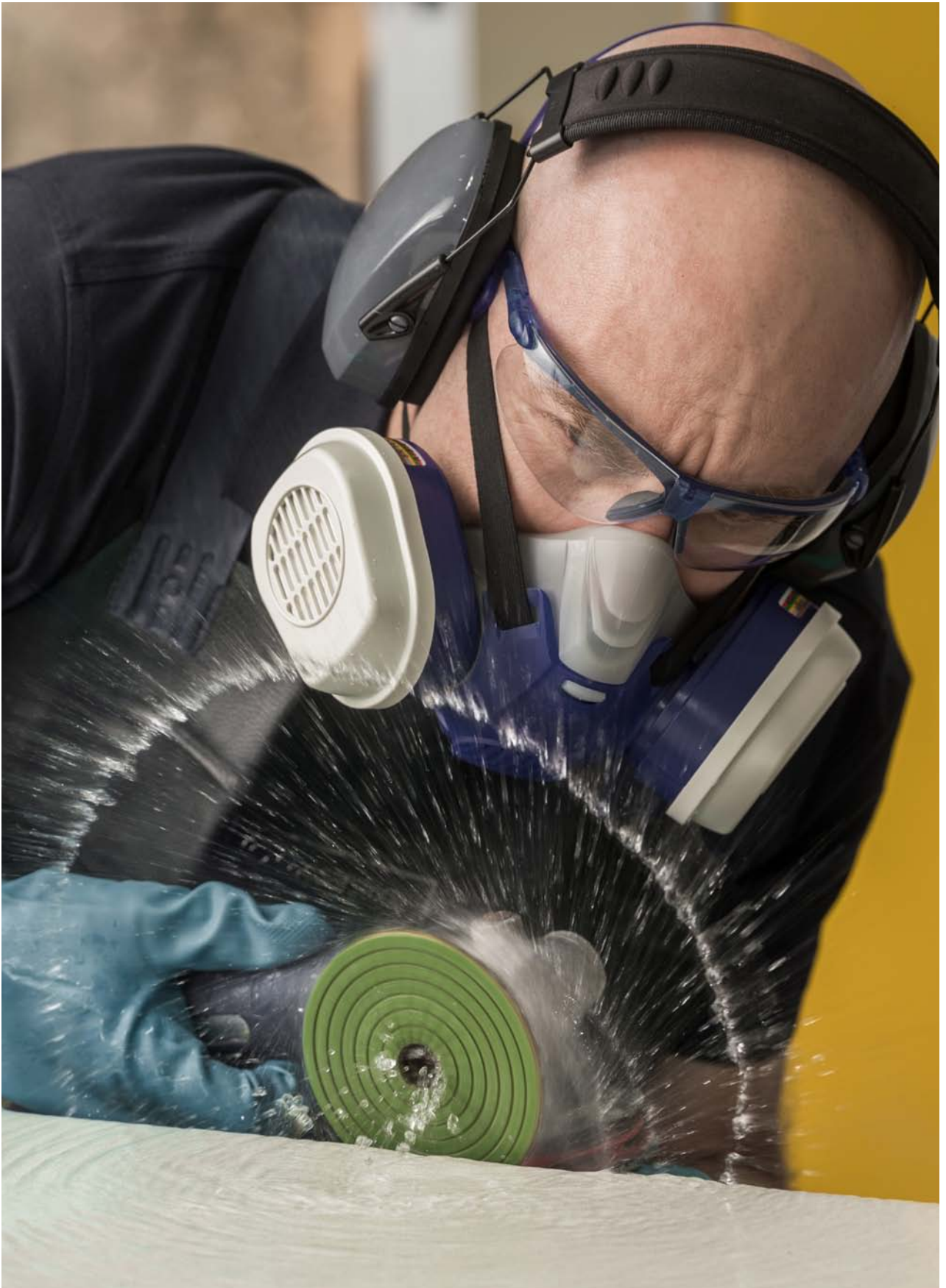

8.5.1 Polished Finishes

- Polished finishes are smooth and shiny.
- Create polished finishes by using diamond polishing pads.
- Avoid overpolishing, i.e., do not use a 3000 grit pad, as this will make the polished area shinier than the surface.

ACCESSORY	GRIT SIZE
Green diamond polishing pad	60
Black diamond polishing pad	80
Red diamond polishing pad	120
Yellow diamond polishing pad	400
White diamond polishing pad	800
Blue diamond polishing pad	1500

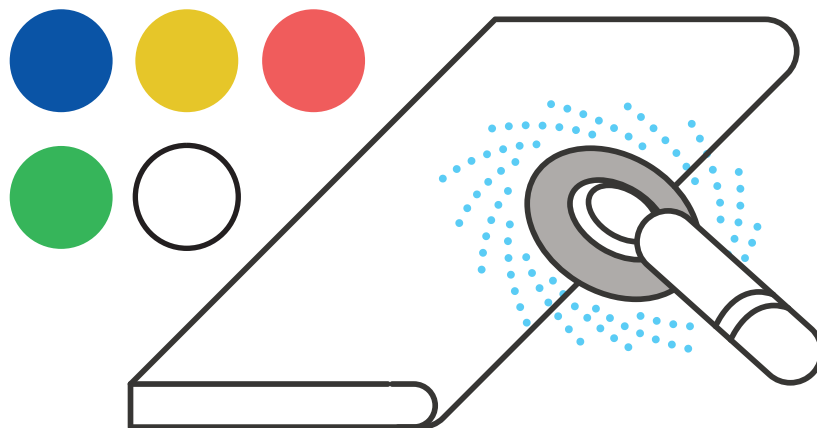

8.5.2 Concrete, Honed/Matt and Natural Finishes

- These finishes are smooth but not shiny.
- Create these finishes by using diamond polishing pads up to 400 grit depending on the finish.

ACCESSORY	GRIT SIZE
Green diamond polishing pad	60
Black diamond polishing pad	80
Red diamond polishing pad	120
Yellow diamond polishing pad	400

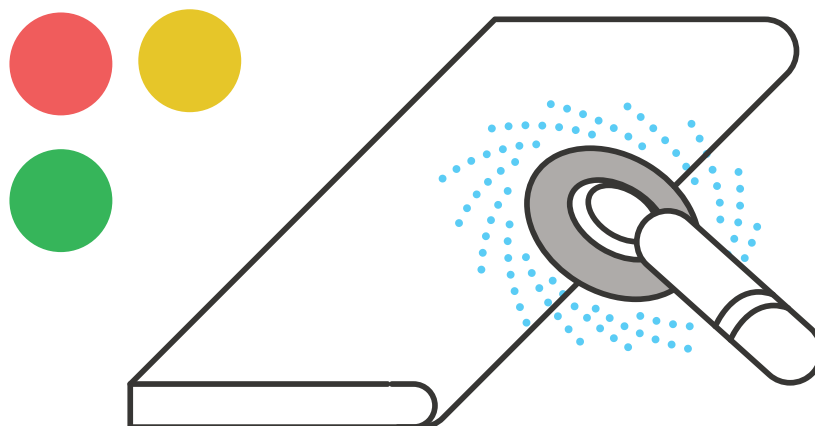

8.5.3 Rough Concrete Finishes

- These finishes are slightly coarse and have a low gloss.
- Create these finishes by using diamond polishing pads **and diamond polishing brushes**.
- Work with brushes with plenty of water.

ACCESSORY	GRIT SIZE
Green diamond polishing pad	60
Diamond polishing brush	60
	120
	400
	800
	1200
	1800

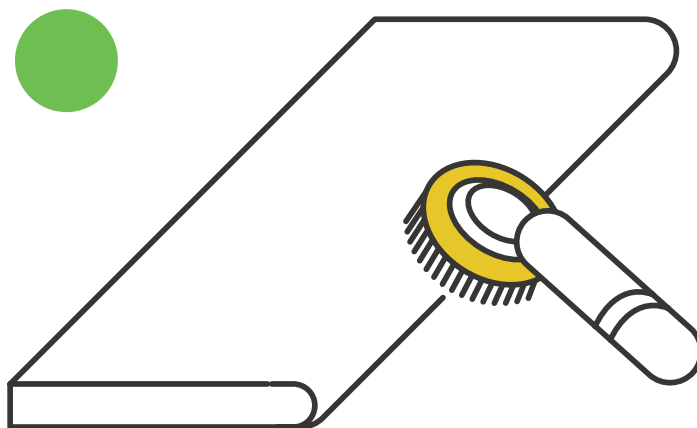

8.6 Support Strips

Glue support strips of Caesarstone surfaces or solid timber to the underside of the edge in order to raise and support the edge where a laminated edge would hinder the opening of the cabinet doors. This also strengthens the edge.

WHOLE LENGTH FRONT AND BACK

Glue the support strips along the whole length of the front and back of the cabinet.

HEIGHT AND WIDTH

The strips should be a minimum of 70 mm (2³/₄") wide, and the same height as the part of the lamination strip that protrudes underneath the slab.

ALIGN JOINS

The support strip should be the same length as the piece of surface to which it is attached. Joins in support strips will, therefore, be aligned with the surface joins.

45° JOINS

Partial support strips are not recommended as they create stress points that could lead to cracking on the countertop above. If, however it is necessary to create support strips out of more than one piece, make a 45° angle diagonal join and cut support pieces on outside corners at a 45° angle; see below.

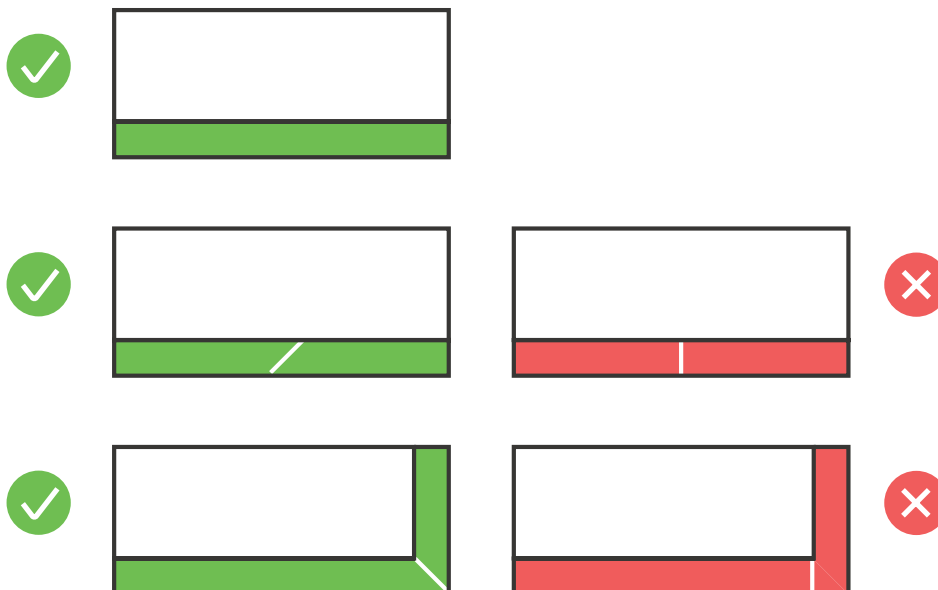
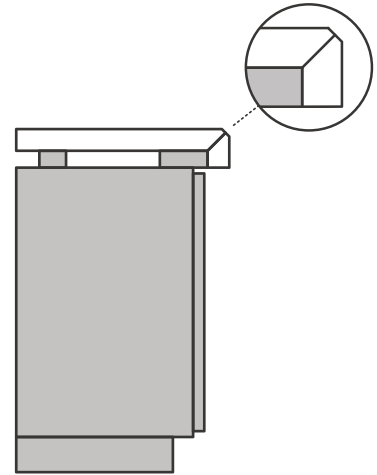



9. Installation

9.1 Preparing the Base Units/Cabinets

Below are technical information and data related to some common applications of Caesarstone quartz and Caesarstone Mineral™ surfaces. For any other applications, please consult your local distributor.

DO NOT FIX TO WALL

Caesarstone surfaces are installed on top of cabinets and are not fixed to the wall.

CABINET REQUIREMENTS

Before installing the surface, ensure that cabinets are complete, stable, level and suitable for bearing the weight of the surface. The cabinets should be fixed to each other and secured to the back wall. Check that the front and back legs are stable and in full contact with the floor.

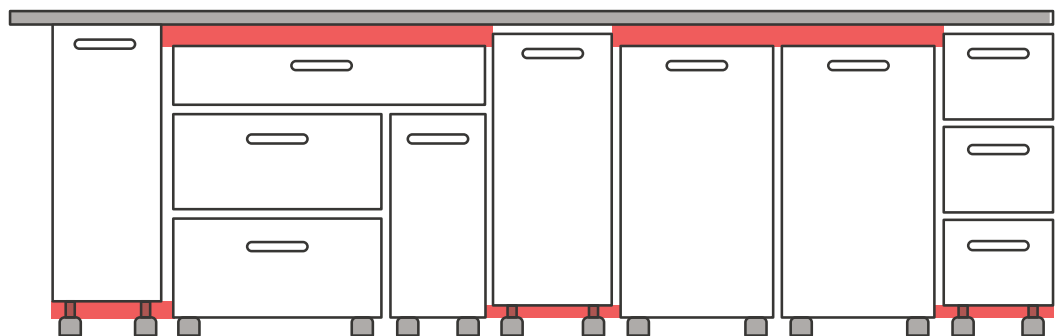
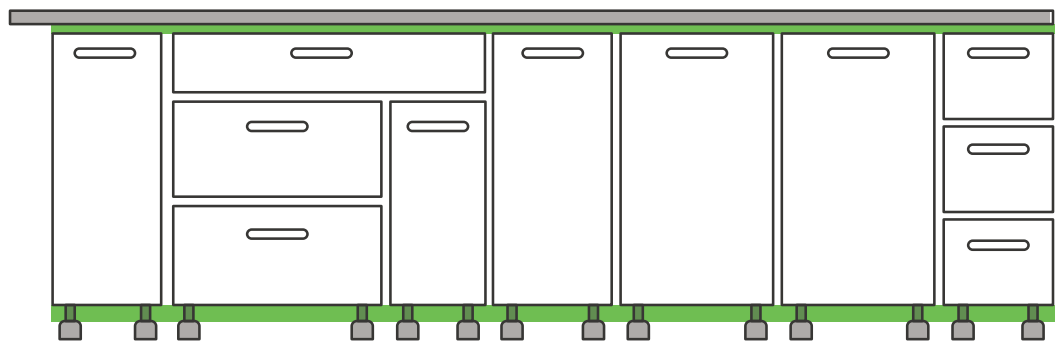

SUPPORT

- Ideally, Caesarstone surfaces should be supported on a subdeck. It is also acceptable for them to be supported on a strong perimeter frame provided that all necessary supports are installed.
- For areas larger than 600 x 900 mm (24" X 36"):
 - for 13 mm and 20 mm surfaces, use a 15 mm ($\frac{5}{8}$ ") plywood subdeck
 - for 30 mm surfaces use a 50 mm x 25 mm (2" X 1") wooden batten/center spine of clear pine or stronger - a full subdeck is not required.
- Provide front-to-back support underneath the surface every 500-600 mm (20-24").
- Provide additional support for any cabinets wider than 600 mm (24").
- For any area with less than four sides, e.g., opening for a dishwasher or undercounter refrigerator, provide support every 200 mm (8") for 20 mm slabs and every 400 mm (16") for 30 mm slabs.
- In cabinets where there will be cutouts or ovens, install vinyl-wrapped, solid timber, vertical rails for additional support. This is especially important when the cooktop/hob cutout is above the oven.
- For cutouts longer than 600 mm (24"), provide side-to-side support beams under the surface.
- Verify that the countertop is sufficiently supported in areas of seams, cutouts and over spaces for appliances such as dishwashers, ovens, washing machines, etc.
- Examples of support are: wooden beams inside cabinets; upright countertop to floor panel.

⚠ Provide support under all countertop seams.

⚠ Attach a solid top on top of undercounter appliances that generate heat. This will provide both support and insulation for the countertops. This is not necessary in the case of fully integrated appliances with integral heat insulation where it would prevent proper alignment with the cabinet doors.

DRAWER CABINETS

Drawer cabinets should have a solid top as vertical rails are not practical.

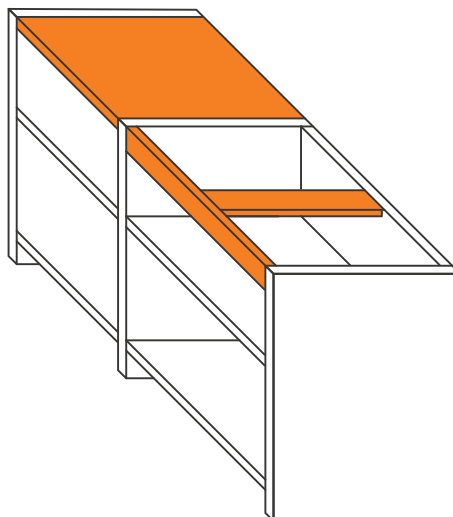

9.2 Countertops

9.2.1 Preparation for Installation

■ CHECK PIECES IN FINAL POSITION

Place all the fabricated pieces of the surface in their final position on the cabinets without adhesive. Check that all the pieces are the correct size, shape and direction in relation to the cabinets and the walls.

■ CHECK EDGES AND CORNERS

Check that all exposed edges and corners are fabricated and rounded as required.

■ CHECK LEVEL

Check with a spirit level and long ruler that the surface is straight and level.

■ ALLOW FOR EXPANSION AND CONTRACTION

Leave a space of 1 mm ($\frac{1}{32}$ ") per linear meter between straight stretches of the surface and each wall for expansion and contraction, but not less than 3 mm ($\frac{1}{8}$ ") in any event.

■ VISUAL INSPECTION

Perform a final visual inspection to ensure that the surface is to your satisfaction.

9.2.2 Seaming

- Part the fabricated pieces of surface slightly at the seam.
- Place a layer of paper, plastic film or plastic tape on the cabinet underneath the seam in order to prevent the adhesive from sticking the surface to the cabinet.
- Prepare a suitable color-matched resin adhesive.

 If necessary, mix the adhesive with pigments using a stainless steel or plastic spatula until achieving the required shade or use a precolored methyl methacrylate type adhesive with a dispensing gun.

 Purge about 50 mm (2") of adhesive from the mixing nozzle to ensure proper mixing when using the precolored methyl methacrylate type adhesive.

-
- Ensure that the seam is clean of debris.
 - Clean the edges to be joined with alcohol.
 - It is recommended to apply tape to the edges of the surface to be seamed in order to prevent staining by adhesives.
 - Spread a generous amount of the adhesive on both sides of the seam.
 - Ensure that the X-shaped pattern in the middle of the seam is filled with adhesive.
 - Close, secure and straighten the seam with clamps or a professional seaming clamp to create a smooth, flush surface.
 - After the adhesive is completely dry, remove the clamps.
 - Remove any excess adhesive with a scraper or razor blade held at an angle to avoid chipping the adhesive.
 - Perform final cleaning with alcohol on a clean white cloth.

 Do not polish seams on Caesarstone surfaces!



9.2.3 Sealing Between the Surface and the Wall

■ TENSION LEGS EVENLY

If the cabinets are supported on adjustable legs, ensure that all legs are evenly tensioned to ensure stability.

■ CLEAN SPACE

Clean the space between the surface and the wall.

■ FILL SPACE

Fill the space generously with a flexible adhesive such as 100% silicone.

- Do not create grooves in the wall for fixing the Caesarstone surface.
- The silicone adhesive prevents water from entering the cabinet.
- For visible joints between the Caesarstone surface and a different material, use colored silicone, a suitable acrylic mastic or paintable latex caulk.

9.2.4 Attaching Caesarstone Surfaces to Cabinets

■ CARCASS/SOLID TOP

Attach the Caesarstone surfaces to the carcass/solid top with dabs of 100% silicone approximately 300 mm apart.

■ STAND-ALONE PIECES

Stand-alone pieces smaller than approximately 1 m² (10 sq ft) should be fixed with a suitable flexible adhesive.

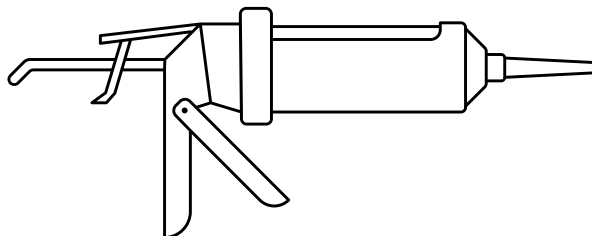

9.3 Sinks

FOLLOW MANUFACTURER'S INSTRUCTIONS

Install, glue and seal the sink per the manufacturer's instructions after installing the surface.

USE 100% SILICONE

Seal the sink to the surface with 100% silicone.

PROVIDE FULL SUPPORT

Ensure that the sink is fully supported inside the cabinet, e.g., by support rails or legs connected to the cabinet, in addition to being attached to the Caesarstone surface.

DO NOT USE SINK CLIPS

Do not attach sink clips or any mechanical fasteners directly to the Caesarstone surface.



Ensure that sufficient space remains underneath the cutout for access and any parts installed underneath the surface, e.g., sink, bolts, soap bottle, etc.

9.4 Cooktops/Hobs

FOLLOW MANUFACTURER'S INSTRUCTIONS

Install cooktops/hobs per the manufacturer's instructions, paying particular attention to insulation requirements and materials.

AVOID COOKTOPS/HOBS ABOVE DRAWER UNITS

Try to avoid installing cooktops/hobs above drawer units as it restricts the use of vertical rails and weakens the support structure under the countertop. If it is unavoidable, drill 5 holes of 80 mm (3 1/8") diameter in the base of the cabinet underneath the cooktops/hobs to allow for ventilation and cooling. If there are shelves, ensure that space is left at the back for ventilation.

INSTALL RAISED COOKTOPS/HOBS OVER CUTOUTS

Raised cooktops/hobs should ideally be installed over cutouts for ventilation and dissipation of heat. If a cutout is not created, drill 5 holes of 80 mm (3 1/8") each in the surface underneath the cooktops/hobs and in any cabinet tops if present.

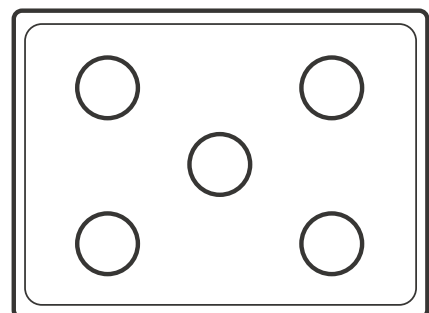

9.5 Utility Rooms

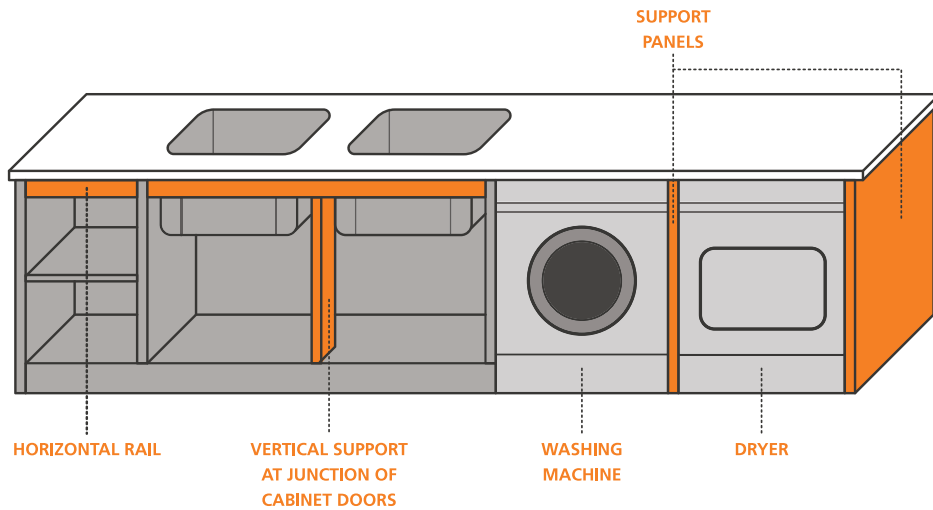

Utility Sinks

Utility sinks require additional reinforcement and support. The dual 45-litre (12 gallon) sink above, which requires a wide cabinet to accommodate it, has a total capacity of 90 litres (24 gallons) so it could potentially hold 90 kg (200 lb) of water. This is equivalent to a person standing on the top in an area with a large cutout.

Washing Machine and Dryer

- Considerable heat is generated by these appliances. Some exhaust through the front while others exhaust through the back; some may need to be ducted.
- Where these appliances are installed side by side, place a support panel between the appliances and either a support panel or cabinet on either side.
- Install a solid plywood top over these appliances to protect the surface from the heat.

💡 These principles apply also to wine refrigerators.

9.6 Accessories

Accessories can be attached to Caesarstone surfaces by mechanical anchoring, adhesive anchoring, or a combination of both. Use a combination of the methods below to attach heavy accessories to Caesarstone surfaces.

9.6.1 Attaching Accessories Mechanically

- Drill a hole of the required size and shape through the material.
- When the back of the slab is accessible (e.g., sink surrounds, countertops and vanities), slot the accessory through the hole and secure it to the back of the slab with the appropriate nut or fastener supplied by the accessory manufacturer.
- 💡 Do not apply excessive pressure when tightening the nut as this may damage the surface. Use a washer or other pressure disperser to avoid creating pressure on a small area.
- When the back of the slab is inaccessible attach the accessory to the substrate behind the material with anti-corrosive screws or bolts of the appropriate size and strength, with the screws or bolts slip-fitted through the material.
- For both types of mechanical attachment: For holes of up to approximately 40 mm (1½"), leave a minimum of 50 mm (2") between the edge of the hole and the edge of the surface/cutout to maintain the strength of the surface. For larger holes, the minimum remaining surrounding surface must be proportionately larger.
- ⚠ Do not attach mechanical fasteners (screws, nails, etc.) directly to Caesarstone surfaces. If it is necessary to secure items to the surface, use flexible adhesive only.

9.6.2 Attaching Accessories with Adhesive

- Most accessories are supplied with an integral self-adhesive pad, which can be attached directly to the surface.
- If the accessory is not supplied with a self-adhesive pad, attach the accessory to the surface with an appropriate adhesive, e.g., 100% silicone.

9.7 Overhangs

An overhang is a surface that is not directly supported by a construction underneath, e.g., a surface that extends past the edge of the supporting cabinet for use as a countertop.

REINFORCEMENT

Extra strength can be provided by laminating the edge of the overhang and attaching another slab of the same thickness underneath. In this case, the bottom slab is attached back to back underneath the surface so that the polished surface is exposed underneath the slab.

PERMITTED OVERHANG

The fabricator will be responsible for determining the required support for the overhang.

 **For all installations the unsupported overhang must be no greater than 1/3 of the complete surface depth.**

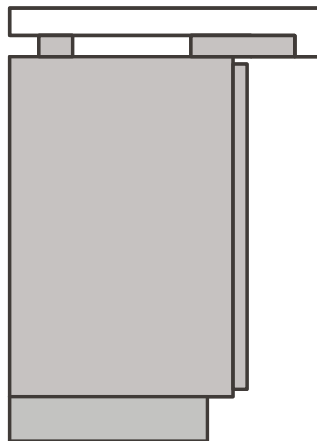

20 MM THICKNESS SLABS	30 MM THICKNESS SLABS	SUPPORT REQUIRED
<300 mm (12")	<400 mm (16")	No additional support required
300-500 mm (12-20")	400-600 mm (16-24")	Support brackets at 600 mm (24") intervals
>500 mm (20")	>600 mm (24")	Legs, columns or panels at 600 mm (24") intervals

 Overhanging surfaces of 13 mm require more support than 20 or 30 mm. Reinforce 13 mm overhangs with strips of Caesarstone surfaces or a metal frame.

OVERHANG SUPPORT GUIDELINES

If the outside corner of a two-direction overhang extends beyond the recommended unsupported overhang limit, provide support by flat brackets as indicated in the diagram below in addition to the recommended support.

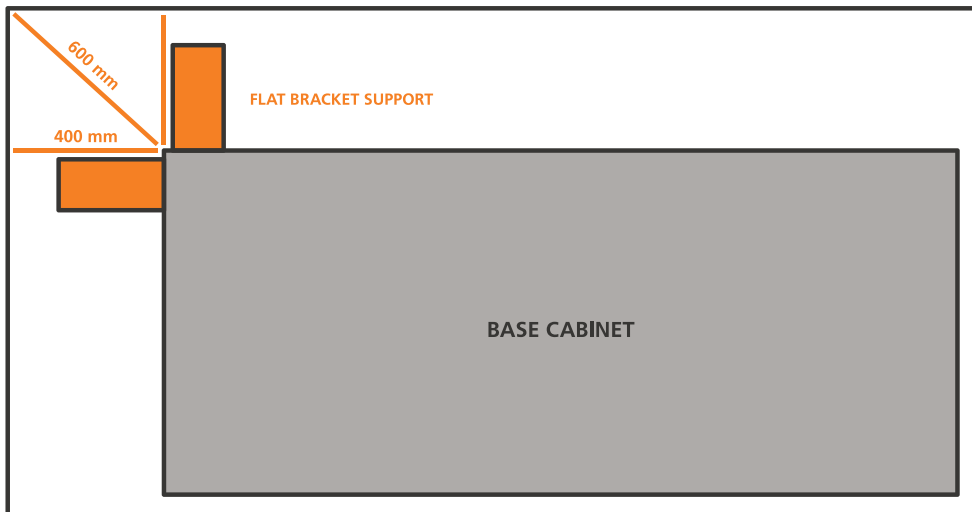

9.8 Tabletops

- When installing a Caesarstone surface as a freestanding tabletop, design the base area of the leg or legs to securely support the table top.
- Spread a suitable flexible adhesive evenly on the top surface area of the supporting leg or legs. Ensure that the adhesive is spread on a sufficient area to secure the surface.
- Tabletops can also be created on a frame as below.

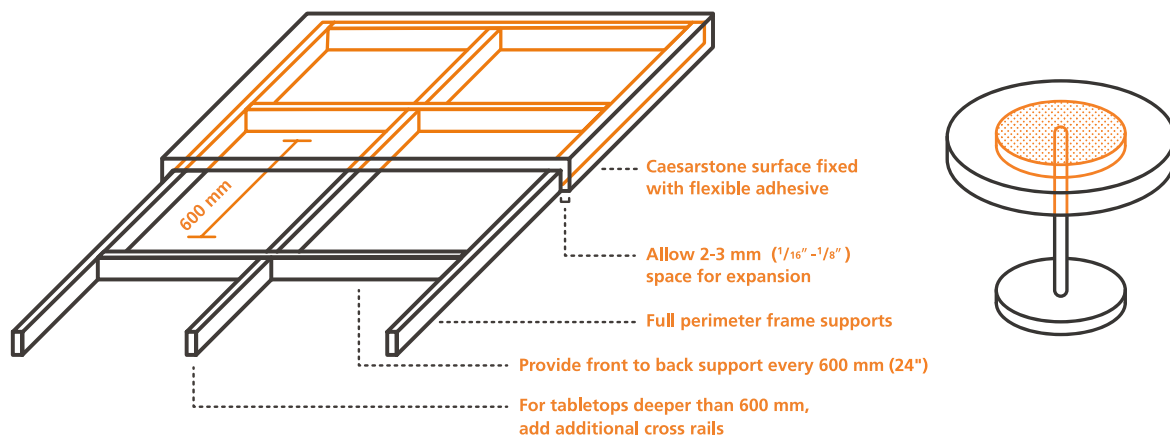

9.9 Finishing Touches

POST-INSTALLATION CLEANING

Thorough post-installation cleaning, particularly of dried adhesive or silicone residue, is of paramount importance as it reduces time-consuming and costly remedial work. Please see detailed instructions for removal of dried adhesive and silicone in Section 10, Care & Maintenance.

PROTECT SURFACE FROM OTHER WORK

If further construction work is to be performed at the job site after the installation of the surface is complete, ensure that the Caesarstone surface is properly protected by covering the entire top with corrugated cardboard or another protective material.

WARN OF POTENTIAL DAMAGE BY OTHER TRADESMEN

Make the customer aware that any following tradesmen must NOT use the new countertop as a work bench, step or standing platform, and that any tradesmen using strong solvents or adhesive must exercise due care.

OBTAIN CUSTOMER SATISFACTION IN WRITING

Caesarstone strongly recommends that customers confirm in writing their satisfaction with the material and workmanship at the end of the installation to cover the fabricator against damage caused by others.

PROVIDE WARRANTY AND CARE & MAINTENANCE INSTRUCTIONS

Make sure to leave the Limited Warranty and Care & Maintenance details for the customer.

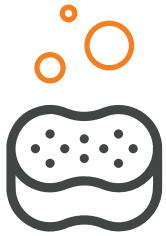

10. Care & Maintenance

GENERAL CLEANING GUIDELINES

Caesarstone* recommends using water and a mild, non-abrasive detergent or a high-quality spray and wipe-type cleaner on a soft cloth or non-abrasive scourer for routine cleaning of Caesarstone surfaces. See Section 10.1, Table 1: Approved Cleaning Materials.

For more information about everyday cleaning please see our website at www.caesarstone.com.

SURFACE FINISHES

Caesarstone surfaces finishes other than Polished may need a little more daily maintenance due to their unique patterns and finishes.

SCRATCH RESISTANCE

Caesarstone surfaces are scratch resistant. However, avoid using sharp objects such as knives or screwdrivers directly on the surface - always use a cutting board.

HEAT RESISTANCE

Sudden and extreme heat, as well as prolonged or direct heat, can damage all natural stone surfaces, including Caesarstone surfaces, especially close to edges. Therefore, always place hot cookware or cooking units such as electric frying pans, crock pots or toaster ovens on trivets, and not directly on the Caesarstone surface.

DARK SURFACES

- Dark surfaces, objects and furniture are characteristically more prone to showing fingerprints and other signs of daily living than light surfaces. As such, dark Caesarstone models may need a little more daily maintenance.
- Dark Caesarstone models, as all dark surfaces, tend to be more sensitive to scratch marks. It is therefore important to protect the surface from sharp objects by using a cutting board.
- Limescale may be more visible on dark surfaces than light ones so liquid should not be left to dry out on the surface.
- Use of cream-textured cleaning products is **not** recommended on dark surfaces.

*Caesarstone is a trademark of Caesarstone Ltd. All other trademarks mentioned in this guide are the trademarks of their respective owners and there is neither connection nor affiliation between Caesarstone Ltd. and these trademarks owners. In addition, please note that the manufacturers of the products listed in this guide are not responsible for Caesarstone's recommended use and they do not endorse such use.

10.1 Stain Removal for Fabricators

These guidelines are for treating specific stains and not for routine cleaning. Use with caution.

GENERAL FACTS

- Most food stains can be removed.
- Chemical stains can be permanent depending on the properties.

GENERAL STAIN REMOVAL GUIDELINES

- Obtain as much information as possible about the use of the countertop and cleaners used before you try to solve the problem.
- Start with mild cleaners and move on to stronger ones if necessary. Cleaning materials from mild to strong are:
 - ▶ dishwashing liquid
 - ▶ mild detergent
 - ▶ cream-textured cleaning products
 - ▶ powdered cleaning products
- Check cream-textured and powdered cleaning products first on an inconspicuous area to ensure that they do not damage the surface.
- Be patient! Some of the cleaning procedures take time.

IDENTIFYING STAIN TYPE

- Most stains and marks are either lighter or darker in color than the surface.
- Darker marks usually mean that something is on the surface, e.g., adhesive, oil, wine, coffee, blood, rust, silicone, sealer, metal.
- In extreme cases darker marks can be a serious burn. Dark burn stains generally cannot be removed.
- Lighter marks usually mean that something has been removed by abrasion, e.g., resin, pigment or patina. If resin or pigment has been removed the damage is usually permanent.
- Lighter marks can also mean that grout, caulk or paint residue is on the surface.

STAIN REMOVAL

General cleaning instructions

- Apply the appropriate cleaning material to a DRY paper towel.
- Gently rub in a circular motion (like waxing a car) about 4 sq ft / 0.4 m² of surface.
- Reapply cleaner to the paper towel and rub another area of the same size.
- Repeat this process on the whole countertop.
- Allow to stand for around 5 minutes; the cleaning material will start to dry.
- Reactivate the cleaning material on the surface with water and gently remove in a circular motion.

Food and beverage stains, magic marker, natural patina, and stubborn stains

- Use an approved spray/gel cleaning material from Table 1: Approved Cleaning Materials, such as Soft Scrub® with Bleach Cleaner Gel.
- For **Concrete, Honed and Rough Concrete finishes** you may also use a cream-textured cleaning material from Table 1: Approved Cleaning Materials, such as Soft Scrub® Cleanser with Bleach.

Rust stains and metal marks

- Place a small amount of Bar Keepers Friend® Cleanser (powder) or oxalic acid on a damp paper towel.
- Wipe very gently in a circular motion.
- Rinse thoroughly with warm water and dry with a paper towel.
- Be very gentle and careful with this method as it may damage the surface finish.

Silicone residue, buildup (long term) stains or mild chemical stains such as tape marks

- Use denatured alcohol and an oxalic acid-based cleaning material such as Bar Keepers Friend® Cleanser (powder).
- Wear rubber gloves for this procedure.
- Pour a small pile of the powder in the center of a paper towel.
- Pour denatured alcohol on the powder and mix into toothpaste consistency.
- Gently rub in a circular motion (like waxing a car) about 4 sq ft / 0.4 m² of surface around the affected area for no more than one minute.
- Wipe the mixture away with water and/or a glass cleaner such as Windex® to neutralize the chemicals.
- The process may need to be repeated over the whole surface if it is over 6 months old or if sealer was applied.
- If you see a dark color coming off onto the paper towel, that means it is working, so repeat the process until the stain is gone.

Dried adhesive, chemical stains and chemical patina*

- Use lacquer thinner and an oxalic acid-based cleaning material such as Bar Keepers Friend® Cleanser (powder).
- Wear rubber gloves for this procedure.
- Pour a small pile of the powder in the center of a paper towel.
- Pour lacquer thinner directly on the powder and mix into toothpaste consistency.
- Gently rub in a circular motion (like waxing a car) about 4 sq ft / 0.4 m² of surface around the affected area for no more than one minute.
- Wipe the mixture away with water and/or a glass cleaner such as Windex® to neutralize the chemicals.
- The process may need to be repeated over the whole surface if it is over 6 months old or if sealer was applied.
- If you see a darker color coming off onto the paper towel, that means it is working, so repeat the process until the stain is gone.

*Chemical patina is a film that develops on the surface from using cleaning materials designed for stone or granite that contain sealer-like chemicals.

PATINA

- Patina naturally forms:
 - ▶ on all quartz products over approximately 6 months of use
 - ▶ when using mild cleaners such as soap and water or Windex®
 - ▶ unless bleach-based cleaner is used regularly
- Patina makes all colors appear slightly darker and shinier.
- It only needs to be deep cleaned if some is removed and creates a different-colored area on the surface (see section: Food and beverage stains, magic marker, natural patina, and stubborn stains).
- Caesarstone surfaces are sold without patina.

WHAT TO AVOID

- Do not allow your Caesarstone surface to come into contact with strong acids or alkalis, oxidizers or similar materials, regardless of pH.
- Do not use harsh cleaning products such as: oven/grill cleaners, dishwasher polishing agents, lye, caustic soda, paint strippers or any products containing trichloroethane or methylene chloride.
- Do not use wax, sealers or other materials that may leave a film on the countertop.
- **Use of acetone is forbidden on Caesarstone surfaces.** Alcohol is recommended for cleaning during installation.
- Do not use abrasive scourers or Mr. Clean Magic Eraser as they can damage the finish/sheen of your surface.
- If the surface comes into contact with any products that might damage it, rinse immediately with plenty of water.
- After cleaning, thoroughly rinse off any cleaning materials with water.
- If you use a cleaning product that is not on our list of recommended cleaning products, check first on an inconspicuous area that it doesn't damage the surface.

TABLE 1: APPROVED CLEANING MATERIALS

Caesarstone recommends using the cleaning products below* and consulting with our representatives if necessary. Please note that not all products are available in all regions.

Household products	10% bleach
	Alcohol
	Hydrogen peroxide 30%
	Vinegar
Commercial spray products	AKEMI® ALGAE AND MOSS REMOVER POWER
	AKEMI® CRYSTAL CLEAN SPRAY
	AKEMI® QUARTZ INTENSIVE CLEANER
	BAR KEEPERS FRIEND® All Purpose POWER SPRAY
	BAR KEEPERS FRIEND® MORE Spray + Foam
	Cif POWER & SHINE KITCHEN
	Caesarstone® Spray Cleaner
	Cif actifizz MULTI-PURPOSE
	Sano® ANTI KALK 4 IN 1 UNIVERSAL
	Soft Scrub® with Bleach Cleaner Gel
Commercial cream-textured products	Astonish CREAM CLEANER Lemon Fresh
	Caesarstone® Cream Cleanser
	Soft Scrub® Cleanser with Bleach
	Vim® Cream Creme

*Caesarstone recommends use of these products based on tests conducted by Caesarstone. The manufacturers of the products listed in this guide are not responsible for such use and do not endorse such use.

TABLE 2: OTHER STAINS

TYPE OF STAIN	CAUSE/SOURCE	TREATMENT/REMARKS
Chemical	Aggressive cleaning materials such as: oven/grill cleaners, dishwasher polishing agents, lye, caustic soda, acetone, paint strippers or any products containing trichloroethane or methylene chloride	Cannot be removed
Heat source - direct/indirect	<ul style="list-style-type: none"> • Hot cookware • Polishing burn • Toaster oven • Grill • Hot plate • Oven/range shelves, trays, vents 	Cannot be removed
Oil - natural	<ul style="list-style-type: none"> • Olive oil • Canola oil, etc. 	See Table 1: Approved Cleaning Materials - commercial products
Oil - synthetic	<ul style="list-style-type: none"> • Machine oils 	See Table 1: Approved Cleaning Materials - commercial products <ul style="list-style-type: none"> • WD40
Cosmetics	<ul style="list-style-type: none"> • Shampoo • Medical creams • Make-up • Eyeliner • Lipstick 	See Table 1: Approved Cleaning Materials - commercial products

TYPE OF STAIN	CAUSE/SOURCE	TREATMENT/REMARKS
Metal	<ul style="list-style-type: none"> • Metal kitchen tools (e.g., knives) • Metal pots • Metal belt buckles 	<ul style="list-style-type: none"> • Metal stains may resemble scratches but they are actually metal residue and easily removed. See section: Rust stains and metal marks • Latex eraser
Food and beverages	<ul style="list-style-type: none"> • Food coloring • Herbs and spices • Red wine • Pomegranates 	See Table 1: Approved Cleaning Materials - commercial products
Colors	<ul style="list-style-type: none"> • Ink • Markers - water based • Markers - oil-based (permanent) • Paint • Print from supermarket bags 	<ul style="list-style-type: none"> • Alcohol • 10% bleach See Table 1: Approved Cleaning Materials - commercial products
Limescale	<ul style="list-style-type: none"> • Hard water deposits 	<ul style="list-style-type: none"> • Vinegar • Limescale remover



11. Environment, Standards & Certificates

At Caesarstone®, minimizing our impact on the environment is a top managerial priority, involving all our employees and departments to assure our sustainability leadership.

We aim to create durable, low-maintenance products that support healthier environments and better use of material resources:

- **LOW MAINTENANCE** - Caesarstone quartz and Caesarstone Mineral™ surfaces require minimal maintenance and significantly reduce the need for sealants, cleaning materials and detergents.
- **HIGH PERFORMANCE AND DURABILITY** - Caesarstone surfaces are long-lasting and durable, delivering both improved life cycle costs and additional investment value.
- **LOW-EMITTING PRODUCTS** - Caesarstone surfaces meet stringent product emissions standards and have very little impact on indoor air quality. All Caesarstone quartz and Caesarstone Mineral™ products are independently certified by the GREENGUARD Certification, which is part of UL Environment, a business unit of UL (Underwriters Laboratories), as low-emitting surfaces.



KOSHER



Declare



USGBC



SCS



NSF



mindful MATERIALS



HPD



ISO 9001:2015
ISO 14001:2015
ISO 45001:2018
OHSAS 18001:2007



Greenguard Gold



Food Contact EC
1935/2004

Caesarstone works with the leading sustainability organizations in the green building sector as part of its sustainability leadership. Our certifications for our manufacturing sites and products support our customers' needs for green and healthy building products and contribute to green building projects.

- The International Living Future Institute's **Declare** label is a sustainability initiative that has been widely adopted as a cross-industry benchmark focusing on ingredient transparency. The Declare label is also Living Building Challenge Red List Approved - deeming Caesarstone quartz and Caesarstone Mineral™ surfaces suitable for use in projects as the products are free from chemicals that have been classified by the ILFI as harmful to human and environmental health.
- **ISO 14001** is the international standard for establishing an environmental management system to guide working towards: meeting environmental goals; monitoring compliance activities; investing in tools for enhancing a quality environment; employee and supplier training; health and safety procedures; and establishing efficient production processes. All Caesarstone's production plants have a certified environmental management system in accord with ISO 14001.
- **OHSAS 18001** and **ISO 45001** are international occupational health and safety management standards designed to support organisations in assessing workplace hazards and implementing preventative measures as part of day-to-day operations. All Caesarstone's production plants have a certified occupational health and safety management system in accord with OHSAS 18001 or ISO 45001.
- **ISO 9001** is the international standard that specifies requirements for a quality management system. Compliance demonstrates the ability to consistently provide products and services that meet customer and regulatory requirements. All Caesarstone's production plants have a certified quality management system in accord with ISO 9001.
- All Caesarstone quartz and Caesarstone Mineral™ surfaces comply with **GREENGUARD** certification, which verifies that Caesarstone products meet the most stringent indoor air emission standards.
- All Caesarstone quartz and Caesarstone Mineral™ surfaces comply with the **GREENGUARD GOLD** standard (formerly known as GREENGUARD Children & Schools Certification), which evaluates the sensitive nature of school populations combined with the unique building characteristics found in schools, and presents the most rigorous product emissions criteria to date.
- The **Health Product Declaration® (HPD) Open Standard*** necessitates full disclosure of the potential chemicals of concern in products by comparing product ingredients to a set of priority "hazard" lists based on the GreenScreen for Safer Chemicals and additional lists from other government agencies.
*The Health Product Declaration® logo is a registered trademark of HPD Collaborative.
- Caesarstone's **Red List Declaration** confirms that to the best of our knowledge Caesarstone quartz and Caesarstone Mineral™ surfaces do not contain any of the hazardous materials that appear on the International Living Future Institute's Red List (<https://living-future.org/declare/declare-about/red-list/>).

-
- As a member of the **United States Green Building Council (USGBC)**, we are a natural partner for green building projects worldwide. For more information, visit new.usgbc.org
 - Developed by the **USGBC**, **LEED** (Leadership in Energy and Environmental Design) is an American accredited rating system for the design, construction and operation of high-performance green buildings. Caesarstone's products can contribute to LEED v3 and LEED v4 projects.
 - Caesarstone's recycled models are **SCS Global Services** certified for recycled content. SCS Global Services is a global leader in independent certification and verification of environmental and sustainable stewardship. Some of our models are made from pre-consumer recycled raw materials such as mirror and glass or high-quality reclaimed post-production waste from the fabrication process.
 - Caesarstone quartz and Caesarstone Mineral™ surfaces are compliant with the International Health and Safety Foundation sanitary standard **NSF51**, ensuring that our working surfaces are safe for use in all food environments. Our non-porous surfaces inhibit the growth of mildew and bacteria, thus creating a hygienic surface.
 - Caesarstone quartz and Caesarstone Mineral™ surfaces comply with the two leading **European Food Contact Materials** regulations: Regulation (EC) No 1935/2004 and Regulation (EC) No 2023/ 2006 on Good Manufacturing Practices.
 - Caesarstone quartz and Caesarstone Mineral™ surfaces are found in the **mindful MATERIALS** Library at www.mindfulmaterials.com. mindful MATERIALS is a user-friendly platform that enables the building industry to obtain information concerning statements and certifications regarding quality and environmental aspects of Caesarstone surfaces.
 - Caesarstone quartz and Caesarstone Mineral™ surfaces are **Kosher** due to their low porosity.



12. Disclaimer

This Guide is intended for use by persons having expertise, professional experience and technical skills, at their own discretion and risk. We accept no responsibility and disclaim all liability for any harmful effects that may be caused by fabrication and installation of our products. The information and recommendations contained herein are based upon data believed to be correct as of the date of publication, based upon our knowledge and experience, and that of our professional partners, based on the most common events recorded while working with Caesarstone slabs. While every precaution has been taken in the preparation of this document, we assume no responsibility for errors or omissions, or for damages resulting from the use of information contained in this document, and in no event shall we be liable for any loss of profit or any other commercial damage caused or alleged to have been caused directly or indirectly as a result of any person relying upon any information contained in this document.

Due to the fact that we cannot foresee or relate to all the different situations that may occur when working with Caesarstone slabs, the instructions in this Guide should be seen purely as working principles. Professional judgment should therefore be employed before performing any actions. A prior trial should be carried out before performing any actions for the first time. Caesarstone representatives are available to answer any questions.

This Guide should not be regarded as a list, an interpretation, or a summary of any laws, standards, rules, orders or safety requirements and they should not be relied upon solely. Fabricators and installers of Caesarstone slabs must be familiar with the relevant local laws and standards, including, but without limitation, Occupational Health and Safety laws and laws relating to the protection of the environment. Any use of the data and information must be determined by the user to be in accordance with any applicable laws and regulations.

No guarantee or warranty of any kind, express or implied, is made of merchantability, fitness for a particular purpose or otherwise.

NOTICE - HAZARDOUS SILICA DUST

Please be reminded that Caesarstone products contain crystalline silica (up to 90%). When processing the products crystalline silica dust is generated. Prolonged/occupational inhalation of crystalline silica dust causes silicosis (an incurable, progressively disabling and sometimes fatal lung disease) and may cause other serious diseases. Do not process this product before implementing all safety measures.

More information about the product characteristics, risks and safety measures appear in Caesarstone's Safety Data Sheet and *Good Practice Guide - Steps to Avoid Health Hazards Related to Crystalline Silica Dust* at: mos.caesarstone.com.

